

C'è un gesto che ognuno di noi compie ogni giorno al sopraggiungere del buio.
Un rito che rappresenta gioia, sicurezza, un momento dedicato allo stare insieme.
Accendere una luce è un'azione semplice ma carica di significati.

Il cliente al centro di ogni scelta
The client at the centre of every choice



Novità, Idee, Soluzioni
Novelties, Ideas, Solution



Assistenza Post Vendita
After Sales Assistance



CHI SIAMO

Garden Luce s.r.l. ha un'esperienza trentennale nella produzione di apparecchi per l'illuminazione.

Progettiamo e realizziamo internamente con cura e professionalità i nostri prodotti secondo le Direttive Europee sulla sicurezza del prodotto. La marcatura CE riportata su ogni prodotto ne è la dichiarazione di conformità.

Disponiamo di un ufficio interno di lighting design composto da professionisti con esperienza e competenze in ambito illuminotecnico, architettonico e progettuale in costante aggiornamento.

I nostri progettisti cureranno tutte le fasi del progetto illuminotecnico, dal concept alla verifica normativa in cantiere e vi seguiranno lungo l'iter di realizzazione, dall'ideazione del tipo di illuminazione alla vostra massima soddisfazione

Le fotografie, i disegni, le quote e le dimensioni in questo catalogo sono a titolo indicativo e non costituiscono alcun impegno per la nostra società.

Garden Luce s.r.l si riserva di apportare, senza preavviso, tutte le modifiche che riterrà opportune nell'interesse della clientela.



WHO WE ARE

Garden Luce s.r.l. has thirty years experience in the production of lighting equipment. We design and manufacture with care and professionalism our products in compliance with the European directives of safety. The CE marking on each product is the declaration of conformity.

We have an inside office of lighting design composed by professionals with experience and improving skills in lighting, architectural and projectual fields.



Our planner will take care of all the phases of the lighting project, from the concept to the application of Community rules in the field.

They will follow you during the realization process, from the ideation to your maximum satisfaction.

All the photo, drawings, dimensions and size in this catalogue are for information purposes only and does not constitute any commitment for our company.

Garden Luce s.r.l reserves the right to introduce, without notice, any changes it deems appropriate in the interest of customers.

GRADO DI PROTEZIONE IP

Nessuna protezione No protection	IP0X		IPX0	Non protetto No protection
Protetto contro corpi solidi di dimensioni superiori a 50mm Protected against solid bodies larger than 50mm	IP1X		IPX1	Caduta verticale di gocce d'acqua Vertically falling drops of water
Protetto contro corpi solidi di dimensioni superiori a 12mm Protected against solid bodies larger than 12mm	IP2X		IPX2	Caduta di gocce d'acqua con inclinazione massima 15° Drops of water with enclosure tilted 15°
Protetto contro corpi solidi di dimensioni superiori a 2.5mm Protected against solid bodies larger than 2.5mm	IP3X		IPX3	Pioggia 60° Rain 60°
Protetto contro corpi solidi di dimensioni superiori a 1mm Protected against solid bodies larger than 1mm	IP4X		IPX4	Spruzzi da tutte le direzioni Splashes from all directions
Protetto contro la polvere Protected against dust	IP5X		IPX5	Getti d'acqua da tutte le direzioni Water jets from all directions
Totalmente protetto contro la polvere Totally protected against dust	IP6X		IPX6	Ondate Waves
			IPX7	Possibile immersione temporanea Temporary immersion
			IPX8	Possibile immersione permanente Possible permanent immersion

SIMBOLI



Classe I
Apparecchi con parti metalliche costantemente collegate al circuito di terra.
Equipment with metal parts constantly connected to the earth circuit.



Classe II
Apparecchi con parti in tensione isolate fra loro e verso l'esterno con un doppio isolamento e senza dispositivi di messa a terra.
Equipment with live parts insulated from one another and from the outside with double insulation and without earthing devices.



Apparecchio idoneo per il montaggio su superfici normalmente infiammabili
Equipment suitable to be fitted on normally inflammable surfaces.



Tutti i prodotti rispondono ai requisiti essenziali alle direttive su:
BASSA TENSIONE 2006/95/CE - Normative EN61347-1 EN61347-2-13 EN50366 - COMPATIBILTA' ELETTRICITA' ELETTRONICHE
Normative EN55015(+A1+A2) EN61000-3-2 (+A2) - EN61000-3-3 EN61547 (+A1) - CEI EN 60598-1 - CEI EN 60598-2-1 - CEI EN 60598-2-4
All the product comply with the essential requirements of:
LOW VOLTAGE 2006/95/CE Directive - Standard EN61347-1 EN61347-2-13 EN50366 - ELECTROMAGNETIC COMPATIBILITY
Standards EN55015(+A1+A2) EN61000-3-2 (+A2) - EN61000-3-3 EN61547 (+A1) - CEI EN 60598-1 - CEI EN 60598-2-1 - CEI EN 60598-2-4



Apparecchio da non mescolare con i rifiuti domestici generici.
L'apparecchio obsoleto va consegnato ad uno dei punti di raccolta previsti per lo smaltimento.
Apparatus not mix with the general household waste.
The outdated equipment is delivery to one of the points collection planned for disposal.

COLORI STRUTTURA



Grafite - GR

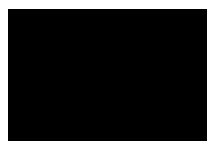

Nero goffrato - NG



Marrone goffrato - MG



Verde goffrato - VG

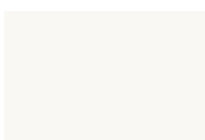

Bianco goffrato - BG



Verde RAL 6009 - VE

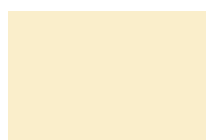

Avorio RAL 1015 - AV



Silver BOND



Nero/Verde - NV



Nero Ruggine - RU



Corten



931 ST - PC

Acciaio Inox AISI 316

Lanterna a Parete

Lanterna a parete stile Provenzale
realizzata con alta Tecnologia taglio Laser

Struttura in Acciaio Aisi 316

Verniciatura a Polveri poliesteri

Qualicoat.

Viteria in Acciaio Inox

Portalampada in Porcellana E27

Copriportalampada in Policarbonato

Vetri Trasparenti e/o Satinati a richiesta

Cavo in PVC doppio isolamento

Connettore IP68

Prodotto per esterno ed interno

Wall Lantern in Provencal style

made with high Technology Laser cutting

Structure in Aisi 316 steel

Polyester powder coating

Qualicoat.

Stainless steel screws

Lampholder in Porcelain E27

Policarbonate lamp cover

Transparent or Satin glasses on request

PVC double insulated cable

IP68 connector

Product for outdoor and indoor



↳

→ 185 ↑ 380 ↗ 250

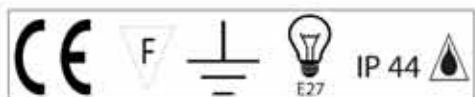



931 SP

Acciaio Inox AISI 316

Lanterna a Parete

Lanterna a parete stile Provenzale
realizzata con alta Tecnologia taglio Laser

Struttura in Acciaio Aisi 316

Verniciatura a Polveri poliesteri

Qualicoat.

Viteria in Acciaio Inox

Portalampada in Porcellana E27

Vetri Trasparenti e/o Satinati a richiesta

Cavo in PVC doppio isolamento

Connettore IP68

Prodotto per esterno ed interno

Wall Lantern in Provencal style

made with high Technology Laser cutting

Structure in Aisi 316 Steel

Polyester powder coating

Qualicoat.

Stainless steel screws

Lampholder in Porcelain E27

Transparent or Satin glasses on request

PVC double insulated cable

IP68 connector

Product for outdoor and indoor



Ø
→ 185 ↑ 330 ↗ 250

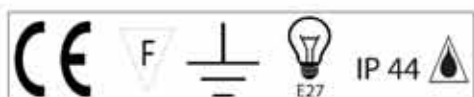



931 S

Acciaio Inox AISI 316

Lanterna a Sospensione

Lanterna a sospensione stile Provenzale
realizzata con alta Tecnologia taglio Laser

Struttura in Acciaio Aisi 316

Verniciatura a Polveri poliesteri
Qualicoat.

Viteria in Acciaio Inox

Portalampada in Porcellana E27

Tiranti in acciaio regoalbili

Vetri Trasparenti e/o Satinati a richiesta

Cavo in PVC doppio isolamento

Prodotto per esterno ed interno

Suspension Lantern in Provencal style
made with high Technology Laser cutting

Structure in Aisi 316 Steel

Polyester powder coating

Qualicoat.

Stainless steel screws

Lampholder in Porcelain E27

Adjustable steel tie rods

Transparent or Satin glasses on request

PVC double insulated cable

Product for outdoor and indoor



σ
→ 185 ↑ 350

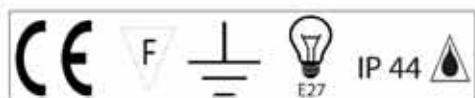



931 L

Acciaio Inox AISI 316

Lanterna Portatile

Lanterna portatile stile Provenzale
realizzata con alta Tecnologia taglio Laser
Struttura in Acciaio Aisi 316
Verniciatura a Polveri poliesteri
Qualicoat.
Viteria in Acciaio Inox
Portalampada in Porcellana E27
Copriportalampada in Policarbonato
Vetri Trasparenti e/o Satinati su richiesta
Cavo in PVC doppio isolamento
Connettore IP68
Prodotto per esterno ed interno

Portable lantern in Provencal style
made with high Technology Laser cutting
Structure in Aisi 316 steel
Polyester powder coating
Qualicoat.
Stainless steel screws
Lampholder in Porcelain E27
Policarbonate lamp cover
Transparent or Satin glasses on request
PVC double insulated cable
IP68 connector
Product for outdoor and indoor



○
→ 185 ↑ 390 ↗ 185

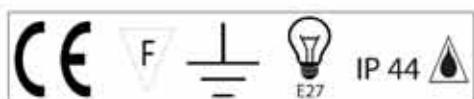



931 Paguro

Acciaio Inox AISI 316

Lanterna con Base

Lanterna con base stile Provenzale
realizzata con alta Tecnologia taglio Laser
Struttura in Acciaio Aisi 316
Verniciatura a Polveri poliesteri
Qualicoat.
Viteria in Acciaio Inox
Portalampada in Porcellana E27
Copriportalampada in Policarbonato
Vetri Trasparenti e/o Satinati su richiesta
Cavo in PVC doppio isolamento
Connettore IP68
Prodotto per esterno ed interno

Lantern with base in Provencal style
made with high Technology Laser cutting
Structure in Aisi 316 steel
Polyester powder coating
Qualicoat.
Stainless steel screws
Lampholder in Porcelain E27
Policarbonate lamp cover
Transparent or Satin glasses on request
PVC double insulated cable
IP68 connector
Product for outdoor and indoor



⊕
→ 230 ↑ 380 ↗ 230

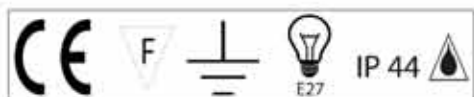



931 1

Acciaio Inox AISI 316

Lanterna a Palo

Lanterna a palo stile Provenzale
realizzata con alta Tecnologia taglio Laser
Struttura in Acciaio Aisi 316 e palo
in alluminio Anticorodal.

Verniciatura a Polveri poliesteri
Qualicoat.

Viteria in Acciaio Inox

Portalampada in Porcellana E27

Copriportalampada in Policarbonato

Vetri Trasparenti e/o Satinati su richiesta

Altezza palo su richiesta

Cavo in PVC doppio isolamento

Connettore IP68

Lantern pole in Provencal style
made with high Technology Laser cutting

Structure in Aisi 316 e steel
anticorodal aluminium pole

Polyester powder coating

Qualicoat.

Stainless steel screws

Lampholder in Porcelain E27

Policarbonate lamp cover

Transparent or Satin glasses on request

Pole height on request

PVC double insulated cable

Connector IP68

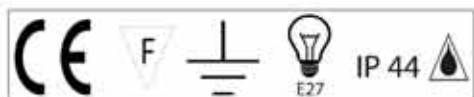
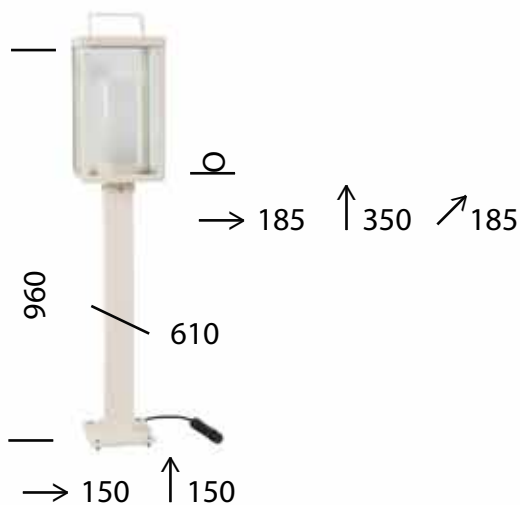



932 ST - PC

Acciaio Inox AISI 316

Lanterna a Parete

Lanterna a parete stile Provenzale
realizzata con alta Tecnologia taglio Laser

Struttura in Acciaio Aisi 316

Verniciatura a Polveri poliesteri

Qualicoat.

Viteria in Acciaio Inox

Portalampada in Porcellana E27

Copriportalampada in Policarbonato

Vetri Trasparenti e/o Satinati a richiesta

Cavo in PVC doppio isolamento

Connettore IP68

Prodotto per esterno ed interno

Wall Lantern in Provencal style

made with high Technology Laser cutting

Structure in Aisi 316 Steel

Polyester powder coating

Qualicoat.

Stainless steel screws

Lampholder in Porcelain E27

Policarbonate lamp cover

Transparent or Satin glasses on request

PVC double insulated cable

IP68 connector

Product for outdoor and indoor



↳ 280 ↑ 430 ↗ 225

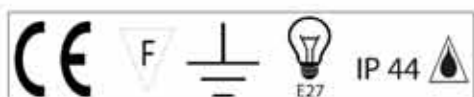



932 SP - PC

Acciaio Inox AISI 316

Lanterna a Parete

Lanterna a parete stile Provenzale
realizzata con alta Tecnologia taglio Laser

Struttura in Acciaio Aisi 316

Verniciatura a Polveri poliesteri
Qualicoat.

Viteria in Acciaio Inox

Portalampada in Porcellana E27

Copriportalampada in Policarbonato

Vetri Trasparenti e/o Satinati a richiesta

Cavo in PVC doppio isolamento

Connettore IP68

Prodotto per esterno ed interno

Wall Lantern in Provencal style

made with high Technology Laser cutting

Structure in Aisi 316 Steel

Polyester powder coating

Qualicoat.

Stainless steel screws

Lampholder in Porcelain E27

Policarbonate lamp cover

Transparent or Satin glasses on request

PVC double insulated cable

IP68 connector

Product for outdoor and indoor



↳

→ 225 ↑ 430 ↗ 280

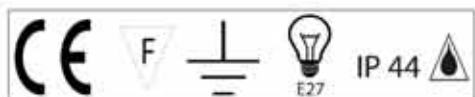



932 S

Acciaio Inox AISI 316

Lanterna a Sospensione

Lanterna a sospensione stile Provenzale
realizzata con alta Tecnologia taglio Laser
Struttura in Acciaio Aisi 316
Verniciatura a Polveri poliesteri
Qualicoat.
Viteria in Acciaio Inox
Portalampada in Porcellana E27
Tiranti in acciaio regoalbili
Vetri Trasparenti e/o Satinati a richiesta
Cavo in PVC doppio isolamento
Prodotto per esterno ed interno

Suspension Lantern in Provencal style
made with high Technology Laser cutting
Structure in Aisi 316 Steel
Polyester powder coating
Qualicoat.
Stainless steel screws
Lampholder in Porcelain E27
Adjustable steel tie rods
Transparent or Satin glasses on request
PVC double insulated cable
Product for outdoor and indoor

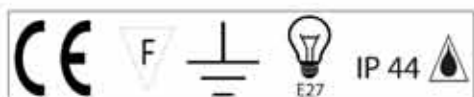



932 L

Acciaio Inox AISI 316

Lanterna con Base

Lanterna con base stile Provenzale
realizzata con alta Tecnologia taglio Laser

Struttura in Acciaio Aisi 316

Verniciatura a Polveri poliesteri
Qualicoat.

Viteria in Acciaio Inox

Portalampada in Porcellana E27

Copriportalampada in Policarbonato

Vetri Trasparenti e/o Satinati su richiesta

Cavo in PVC doppio isolamento

Connettore IP68

Prodotto per esterno ed interno

Lantern with base in Provencal style
made with high Technology Laser cutting

Structure in Aisi 316 steel

Polyester powder coating

Qualicoat.

Stainless steel screws

Lampholder in Porcelain E27

Policarbonate lamp cover

Transparent or Satin glasses on request

PVC double insulated cable

IP68 connector

Product for outdoor and indoor



⊕
→ 250 ↑ 450 ↗ 250

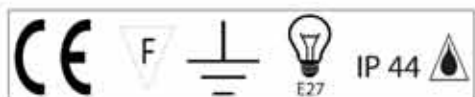



Lanterna con base stile Provenzale
realizzata con alta Tecnologia taglio Laser
Struttura in Acciaio Aisi 316
Verniciatura a Polveri poliesteri
Qualicoat.
Viteria in Acciaio Inox
Portalampada in Porcellana E27
Copriportalampada in Policarbonato
Vetri Trasparenti e/o Satinati a richiesta
Cavo in PVC doppio isolamento
Connettore IP68
Prodotto per esterno ed interno

Lantern whit base in Provençal style
made with high Technology Laser cutting
Structure in Aisi 316 Steel
Polyester powder coating
Qualicoat.
Stainless steel screws
Lampholder in Porcelain E27
Policarbonate lamp cover
Transparent or Satin glasses on request
PVC double insulated cable
IP68 connector
Product for outdoor and indoor

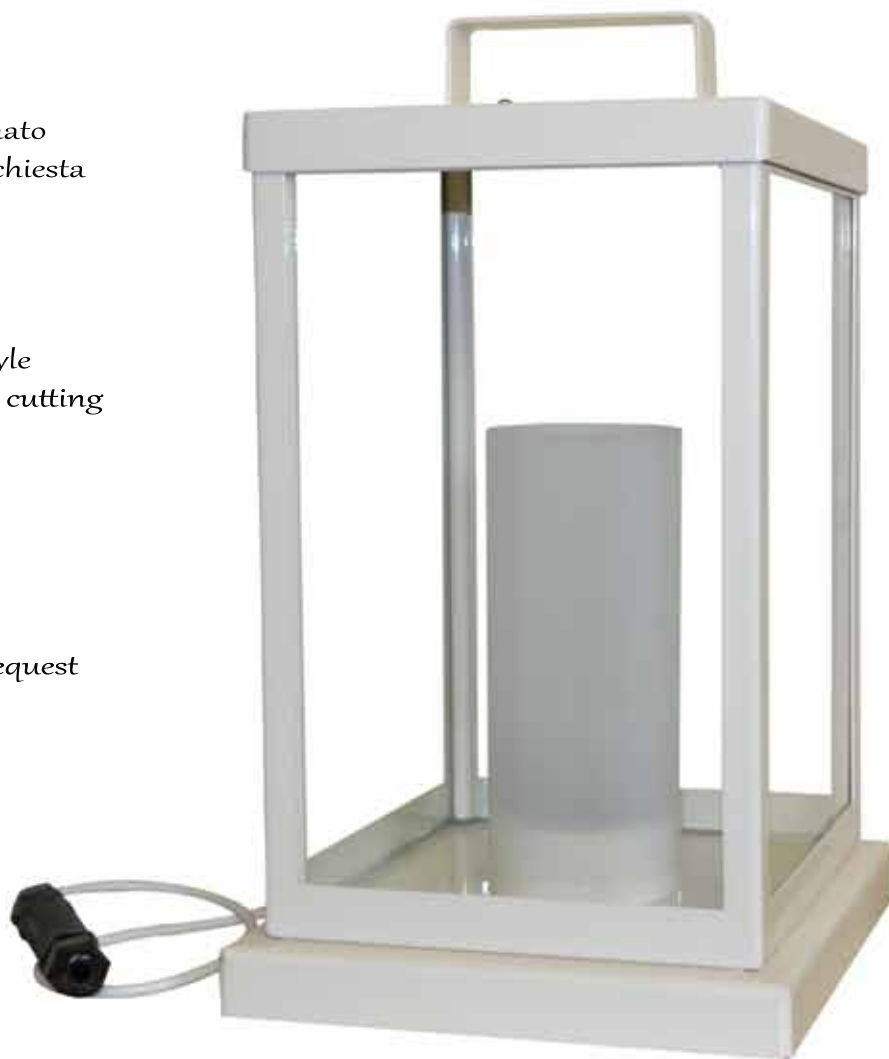

⊙

→ 250 ↑ 450 ↗ 250

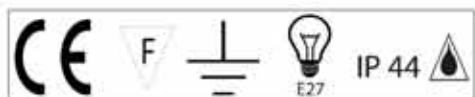



932 1 Acciaio Inox AISI 316

Lanterna a Palo

Lanterna a palo stile Provenzale
realizzata con alta Tecnologia taglio Laser
Struttura in Acciaio Aisi 316 e palo
in alluminio Anticorodal.

Verniciatura a Polveri poliesteri
Qualicoat.

Viteria in Acciaio Inox

Portalampada in Porcellana E27

Copriportalampada in Policarbonato

Vetri Trasparenti e/o Satinati su richiesta

Altezza palo su richiesta

Cavo in PVC doppio isolamento

Connettore IP68

Lantern pole in Provencal style
made with high Technology Laser cutting

Structure in Aisi 316 e steel
anticorodal aluminium pole

Polyester powder coating

Qualicoat.

Stainless steel screws

Lampholder in Porcelain E27

Policarbonate lamp cover

Transparent or Satin glasses on request

Pole height on request

PVC double insulated cable

Connector IP68

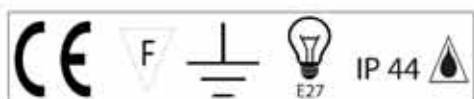
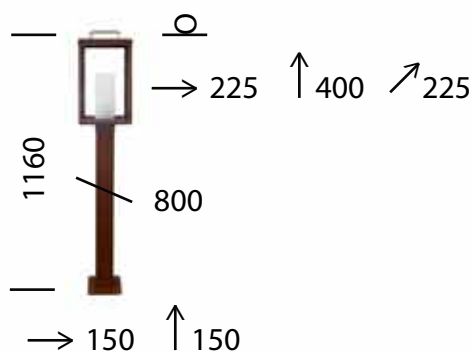



933 ST

Acciaio Inox AISI 316

Lanterna a Parete

Lanterna a parete stile Provenzale
realizzata con alta Tecnologia taglio Laser

Struttura in Acciaio Aisi 316

Verniciatura a Polveri poliesteri

Qualicoat.

Viteria in Acciaio Inox

Portalampada in Porcellana E27

Copriportalampada in Policarbonato

Vetri Trasparenti e/o Satinati a richiesta

Cavo in PVC doppio isolamento

Connettore IP68

Prodotto per esterno ed interno

Wall Lantern in Provencal style

made with high Technology Laser cutting

Structure in Aisi 316 Steel

Polyester powder coating

Qualicoat.

Stainless steel screws

Lampholder in Porcelain E27

Policarbonate lamp cover

Transparent or Satin glasses on request

PVC double insulated cable

IP68 connector

Product for outdoor and indoor



↳ 230 ↑ 620 ↗ 230

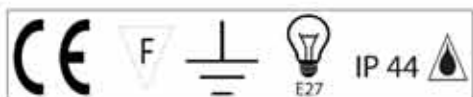



933 L

Acciaio Inox AISI 316

Lanterna con Base

Lanterna con base stile Provenzale
realizzata con alta Tecnologia taglio Laser
Struttura in Acciaio Aisi 316
Verniciatura a Polveri poliesteri
Qualicoat.
Viteria in Acciaio Inox
Portalampada in Porcellana E27
Copriportalampada in Policarbonato
Vetri Trasparenti e/o Satinati su richiesta
Cavo in PVC doppio isolamento
Connettore IP68
Prodotto per esterno ed interno

Lantern with base in Provencal style
made with high Technology Laser cutting
Structure in Aisi 316 steel
Polyester powder coating
Qualicoat.
Stainless steel screws
Lampholder in Porcelain E27
Polycarbonate lamp cover
Transparent or Satin glasses on request
PVC double insulated cable
IP68 connector
Product for outdoor and indoor



→ 250 ↑ 630 ↗ 170

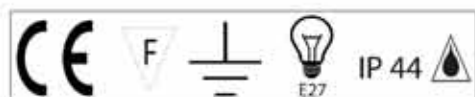



933 Paguro

Acciaio Inox AISI 316

Lanterna con Base

Lanterna con base stile Provenzale
realizzata con alta Tecnologia taglio Laser
Struttura in Acciaio Aisi 316
Verniciatura a Polveri poliesteri
Qualicoat.
Viteria in Acciaio Inox
Portalampada in Porcellana E27
Copriportalampada in Policarbonato
Vetri Trasparenti e/o Satinati su richiesta
Cavo in PVC doppio isolamento
Connettore IP68
Prodotto per esterno ed interno

Lantern with base in Provencal style
made with high Technology Laser cutting
Structure in Aisi 316 steel
Polyester powder coating
Qualicoat.
Stainless steel screws
Lampholder in Porcelain E27
Policarbonate lamp cover
Transparent or Satin glasses on request
PVC double insulated cable
IP68 connector
Product for outdoor and indoor



→ 250 ↑ 630 ↗ 170

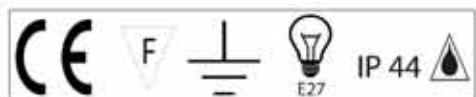



934 Paguro

Acciaio Inox AISI 316

Lanterna con Base

Lanterna con base stile Provenzale
realizzata con alta Tecnologia taglio Laser
Struttura in Acciaio Aisi 316
Verniciatura a Polveri poliesteri
Qualicoat.
Viteria in Acciaio Inox
Portalampada in Porcellana E27
Copriportalampada in Policarbonato
Vetri Trasparenti e/o Satinati su richiesta
Cavo in PVC doppio isolamento
Connettore IP68
Prodotto per esterno ed interno

Lantern with base in Provencal style
made with high Technology Laser cutting
Structure in Aisi 316 steel
Polyester powder coating
Qualicoat.
Stainless steel screws
Lampholder in Porcelain E27
Policarbonate lamp cover
Transparent or Satin glasses on request
PVC double insulated cable
IP68 connector
Product for outdoor and indoor



→ 250 ↑ 640 ↗ 250

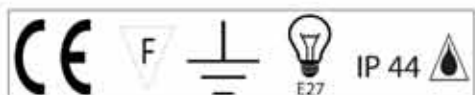



935 Paguro

Acciaio Inox AISI 316

Lanterna con Base

Lanterna con base stile Provenzale
realizzata con alta Tecnologia taglio Laser
Struttura in Acciaio Aisi 316
Verniciatura a Polveri poliesteri
Qualicoat.
Viteria in Acciaio Inox
Portalampada in Porcellana E27
Copriportalampada in Policarbonato
Vetri Trasparenti e/o Satinati su richiesta
Cavo in PVC doppio isolamento
Connettore IP68
Prodotto per esterno ed interno

Lantern with base in Provencal style
made with high Technology Laser cutting
Structure in Aisi 316 steel
Polyester powder coating
Qualicoat.
Stainless steel screws
Lampholder in Porcelain E27
Policarbonate lamp cover
Transparent or Satin glasses on request
PVC double insulated cable
IP68 connector
Product for outdoor and indoor



⊖
→ 320 ↑ 840 ↗ 320

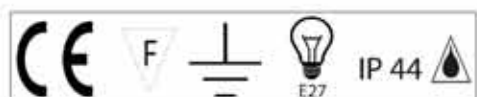



936 A

Acciaio Inox AISI 316

Lanterna a Parete

Lanterna a parete stile Provenzale
realizzata con alta Tecnologia taglio Laser

Struttura in Acciaio Aisi 316

Verniciatura a Polveri poliesteri

Qualicoat.

Viteria in Acciaio Inox

Portalampada in Porcellana E27

Vetri Trasparenti e/o Satinati a richiesta

Cavo in PVC doppio isolamento

Connettore IP68

Prodotto per esterno ed interno

Wall Lantern in Provencal style

made with high Technology Laser cutting

Structure in Aisi 316 Steel

Polyester powder coating

Qualicoat.

Stainless steel screws

Lampholder in Porcelain E27

Transparent or Satin glasses on request

PVC double insulated cable

IP68 connector

Product for outdoor and indoor



↳ 200 ↑ 310 ↗ 100

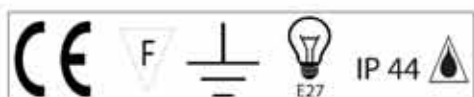



937 A

Acciaio Inox AISI 316

Lanterna a Parete

Lanterna a parete stile Provenzale
realizzata con alta Tecnologia taglio Laser
Struttura in Acciaio Aisi 316
Verniciatura a Polveri poliesteri
Qualicoat.
Viteria in Acciaio Inox
Portalampada in Porcellana E27
Vetri Trasparenti e/o Satinati a richiesta
Cavo in PVC doppio isolamento
Connettore IP68
Prodotto per esterno ed interno

Wall Lantern in Provençal style
made with high Technology Laser cutting
Structure in Aisi 316
Polyester powder coating
Qualicoat.
Stainless steel screws
Lampholder in Porcelain E27
Transparent or Satin glasses on request
PVC double insulated cable
IP68 connector
Product for outdoor and indoor



↳
→ 280 ↑ 410 ↗ 150

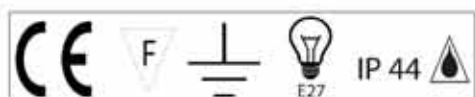



938 A

Acciaio Inox AISI 316

Lanterna a Parete

Lanterna a parete stile Provenzale
realizzata con alta Tecnologia taglio Laser

Struttura in Acciaio Aisi 316

Verniciatura a Polveri poliesteri

Qualicoat.

Viteria in Acciaio Inox

Portalampada in Porcellana E27

Copriportalampada in Policarbonato

Vetri Trasparenti e/o Satinati a richiesta

Cavo in PVC doppio isolamento

Connettore IP68

Prodotto per esterno ed interno

Wall Lantern in Provencal style

made with high Technology Laser cutting

Structure in Aisi 316 Steel

Polyester powder coating

Qualicoat.

Stainless steel screws

Lampholder in Porcelain E27

Policarbonate lamp cover

Transparent or Satin glasses on request

PVC double insulated cable

IP68 connector

Product for outdoor and indoor



b
→ 285 ↑ 350 ↗ 150

