

**Struttura:** alluminio a gravità, pressofuso ed estruso.

**Diffusore:** in vetro soffiato, vetro a lastra.

A richiesta globo in PMMA e diffusori in PC.

**Lampada:** incandescenza, compatte integrate e a scarica.

**Viteria:** inox.

**Cablaggio:** portalampade porcellana E27, fili in teflon,

morsettiera in nylon. A richiesta accessori per lampade a scarica.

**Trattamento:** anticorrosivo, elettroforesi catodica.

**Verniciatura:** polveri poliesteri.

**Structure:** gravity diecast aluminium, diecast and extruded aluminium

**Diffuser:** blown glass or panel glass. PMMA globe and PC panels available.

**Bulb:** incandescent, integrated compact, discharge lamps.

**Fasteners:** stainless steel.

**Wiring:** E27 porcelain lampholder, teflon covered wires, nylon terminal block. Accessories for discharge lamps available.

**Coating:** anti-corrosion, cathodic electrophoretic.

**Paint finish:** polyester powder.

**Struktur:** Aluminium-Schwerkraftguss und-druckguss, gepresstes Aluminium.

**Diffusor:** geblasenes Glas oder Glasscheiben.

PMMA-Kugel und PC-Scheiben verfügbar.

**Lampe:** Glühlampen, kompakt integriert, Metaldampflampen.

**Schrauben:** Edelstahl.

**Verkabelung:** Porzellan-Lampenfassung E27, Teflonleitungen, Klemmleiste aus Nylon. Metaldampflampenzubehör verfügbar.

**Behandlung:** Korrosionsschutz, kathodische Elektrophorese.

**Lackierung:** Polyesterpulver.

**Structure:** aluminium à gravité, moulé sous pression et extrudé.

**Diffuseur:** verre soufflé ou plaque. Boule PMMA et plaque PC sur demande

**Ampoule:** à incandescence, compactes intégrées, lampes à décharge.

**Vis:** inox.

**Câblage:** douille porcelaine E27, fils téflon, bornier nylon.

Accessoires pour lampes à décharge sur demande.

**Traitement:** anticorrosion, électrophorèse cathodique.

**Peinture:** poudres polyester.

**Estructura:** aluminio por gravedad y fundido a presión, extrusión de aluminio.

**Difusor:** vidrio soplado o laminado. Globo PMMA y PC laminado sobre pedido.

**Bombilla:** incandescencia, compactas integradas, lámparas de descarga.

**Tornillería:** inox.

**Cableado:** portalámparas porcelana E27, hilos con teflon, bornera en nylon. Accesorios para lámparas de descarga sobre pedido

**Tratamiento:** anticorrosivo, electroforesis catódica.

**Pintado:** polvos poliésteres.





ANGURIA FRUTTA

IP44 ▲ ▼ CE  
 E27 Classe I  
 IAA 200W  
 FBT 33W  
 QB 160W

**PMMA** ●  
 IP44 ▲ ▼ CE  
 E27 Classe I  
 IAA 75W  
 FBT 27W

**21020** → **210202**  
 Ø 55      Ø 60

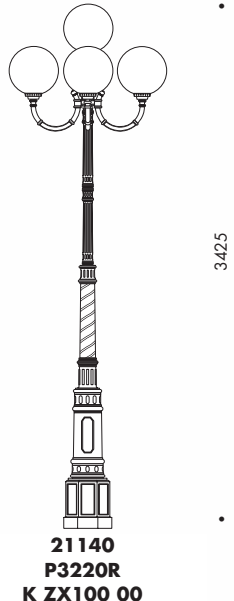
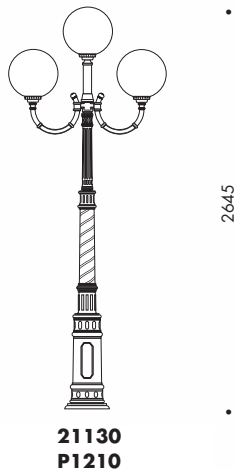
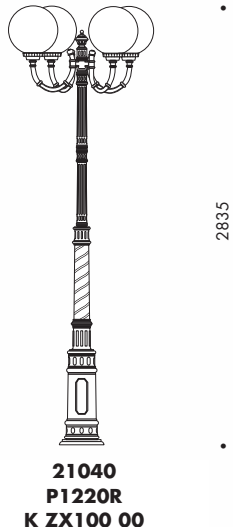
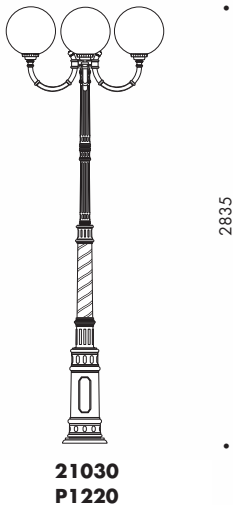
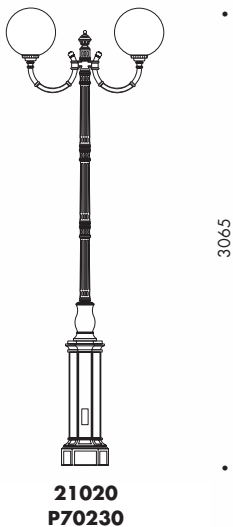
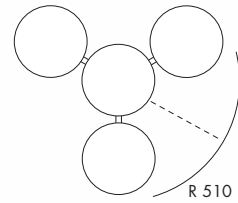
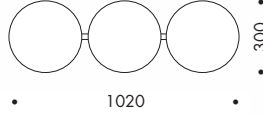
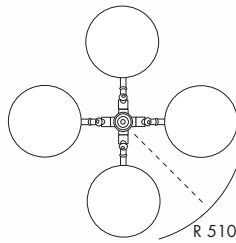
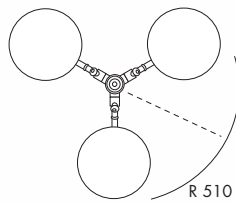
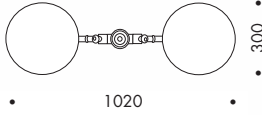
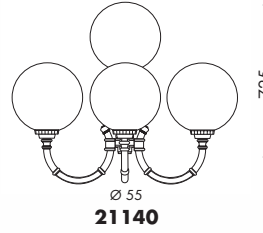
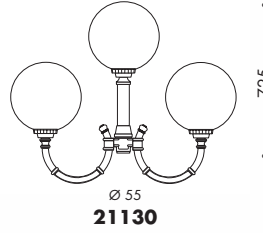
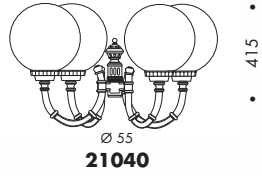
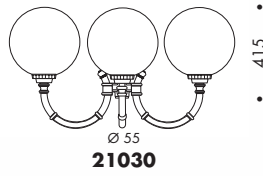
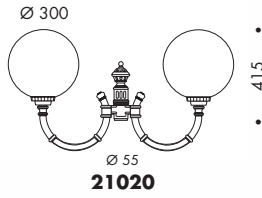



# Sheraton

GRUPPI LANTERNE GRANDI

big lantern groups / grosse Laternen-Gruppen / ganne des grandes a plusieurs tetes / grupos de farolas grandes





IP44 ▲ ▼ CE  
 E27 Classe I  
 IAA 200W  
 FBT 33W  
 QB 160W

**21023** → **210232**  
 Ø 55      Ø 60

**PMMA** ●  
 IP44 ▲ ▼ CE  
 E27 Classe I  
 IAA 75W  
 FBT 27W

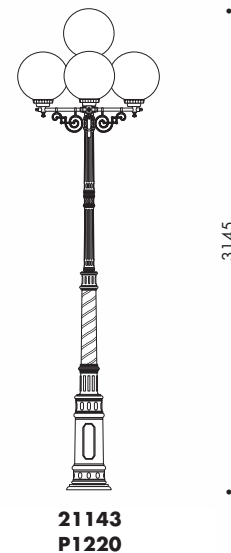
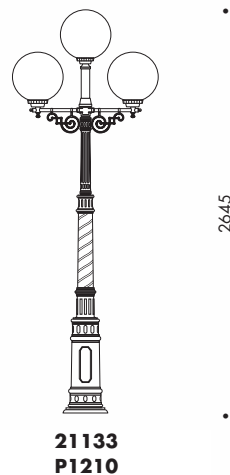
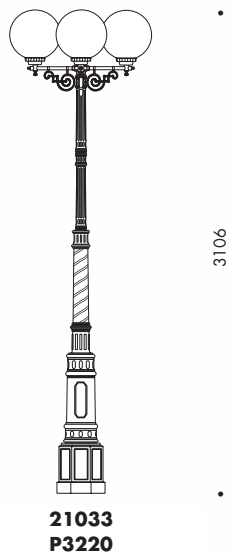
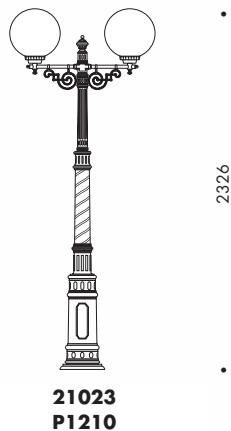
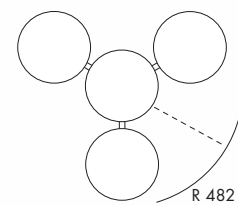
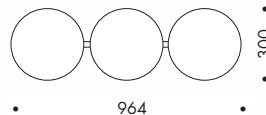
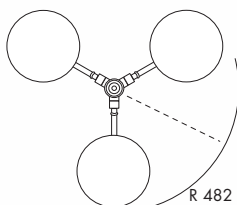
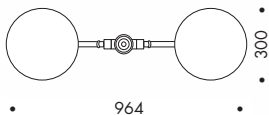
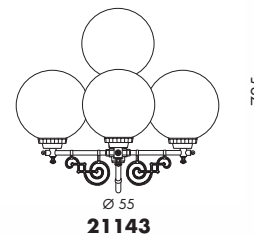
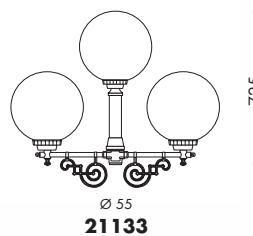
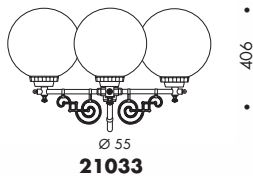
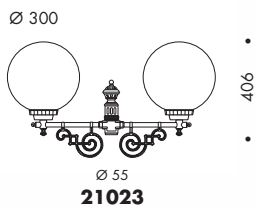

**GRUPPI LANTERNE GRANDI**  
 big lantern groups  
 grosse Laternen-Gruppen  
 gamme des grandes a plusieurs tetes  
 grupos de farolas grandes









IP44 ▲ ▼ CE ⊕  
 E27 Classe I ⊕  
 IAA 200W ⚡  
 FBT 33W ⚡  
 QB 160W ⚡

**PMMA** ●  
 IP44 ▲ ▼ CE ⊕  
 E27 Classe I ⊕  
 IAA 75W ⚡  
 FBT 27W ⚡

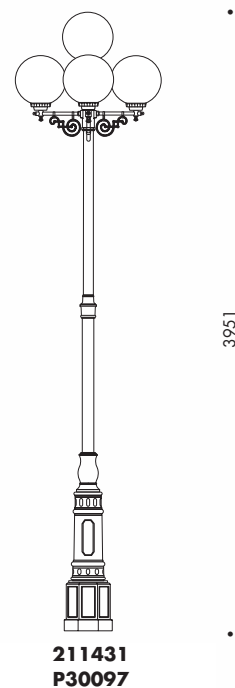
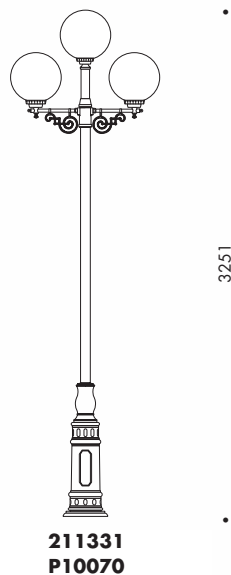
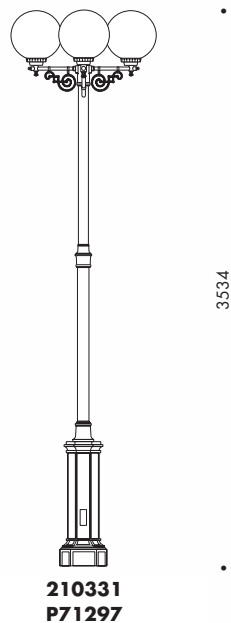
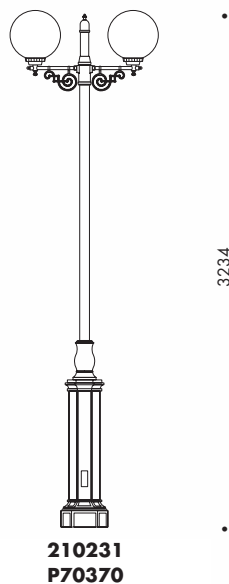
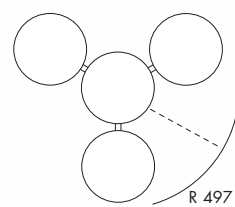
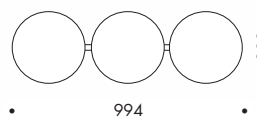
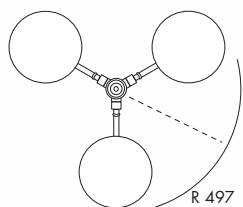
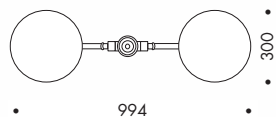
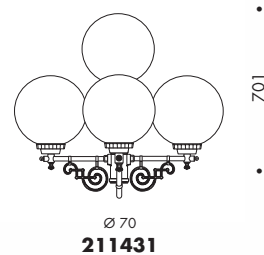
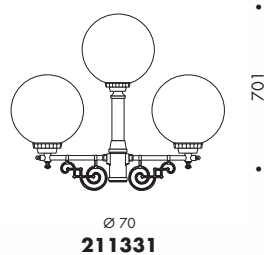
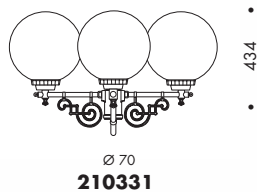
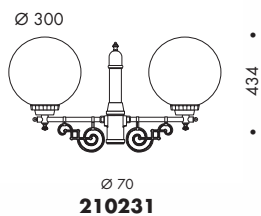



IP65  $\blacklozenge$   $\blacktriangle$   $\blacktriangle$   $\blacktriangle$   $\text{CE}$  solo gruppo ottico  
 PMMA trasparente con frangiluce o opale  
 E27 Classe I  $\oplus$   
 IAA 150W  $\leftarrow$  trasparente con frangiluce  
 FBT 27W  $\leftarrow$   
 IAA 100W  $\leftarrow$  opale

Accessori Lampade a SCARICA				
Codice	SE/ST	ME/MT	QE	
art. S	70W	70W		E27
art. X			80W	E27
art. Y			125W	E27

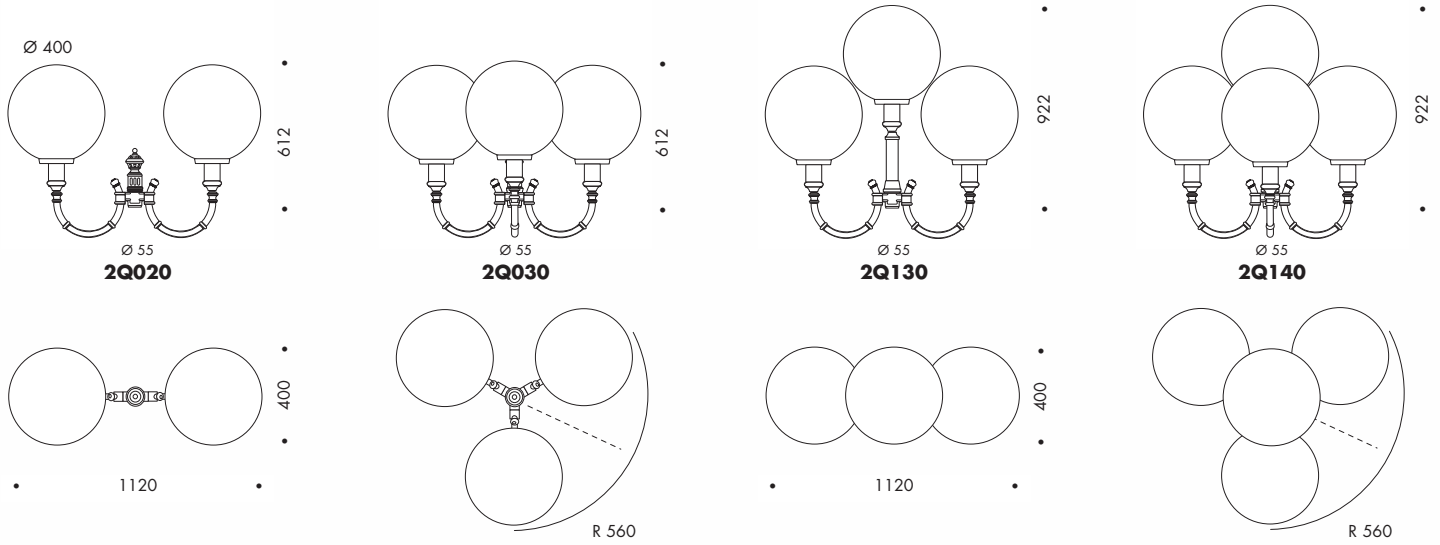

Available with clear and milky acrylic diffusers.

Nur mit klaren und opal acryl Diffusor erhältlich.

Disponible avec boules en métacrylate transparent et opal.

Disponibles con globos en metacrilato transparente y opal.

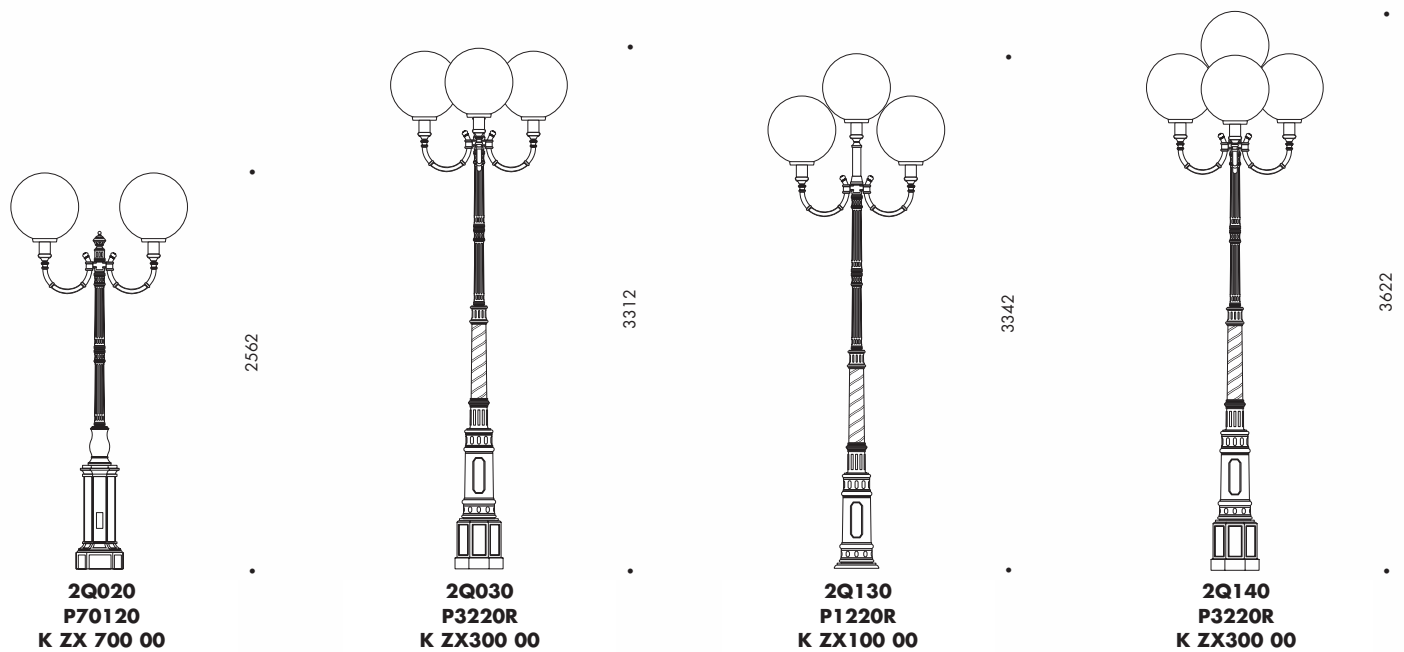

IP65 ✦ ▲▲ CE solo gruppo ottico  
 PMMA trasparente con frangiluce o opale  
 E27 Classe I ⊕  
 IAA 150W ↻ trasparente con frangiluce  
 FBT 27W ↻  
 IAA 100W ↻ opale

Accessori Lampade a SCARICA				
Codice	SE/ST	ME/MT	QE	
art. S	70W	70W		E27
art. X			80W	E27
art. Y			125W	E27

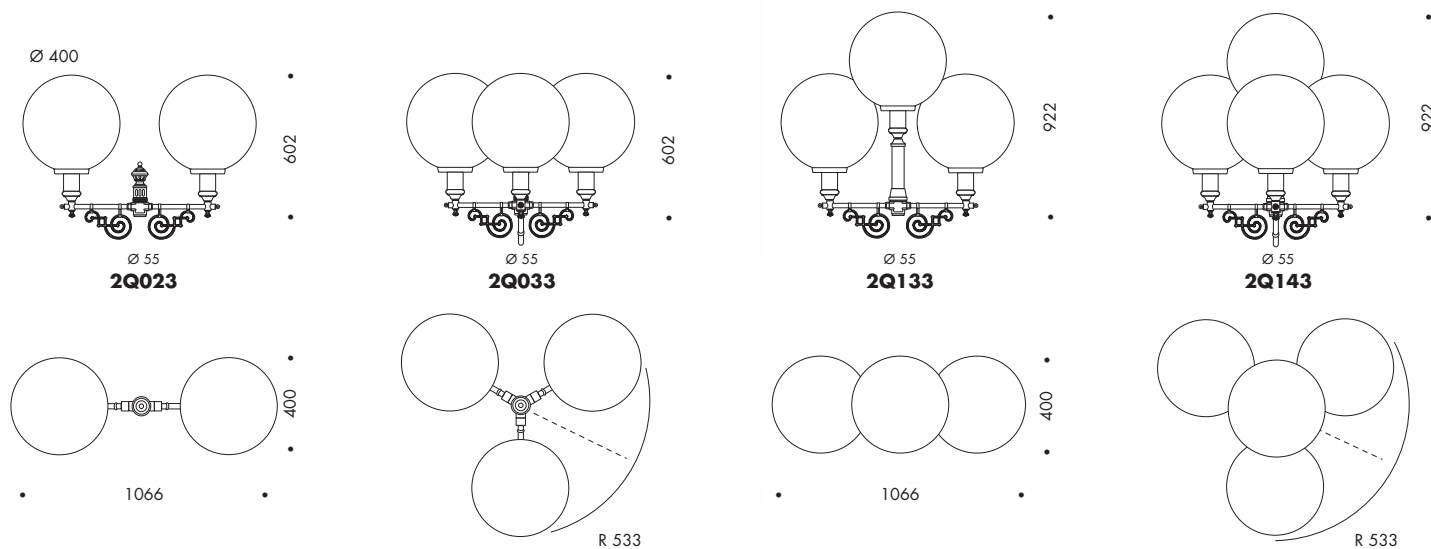

Available with clear and milky acrylic diffusers.

Nur mit klaren und opal acryl Diffusor erhältlich.

Disponible avec boules en métacrylate transparent et opal.

Disponibles con globos en metacrilato transparente y opal.

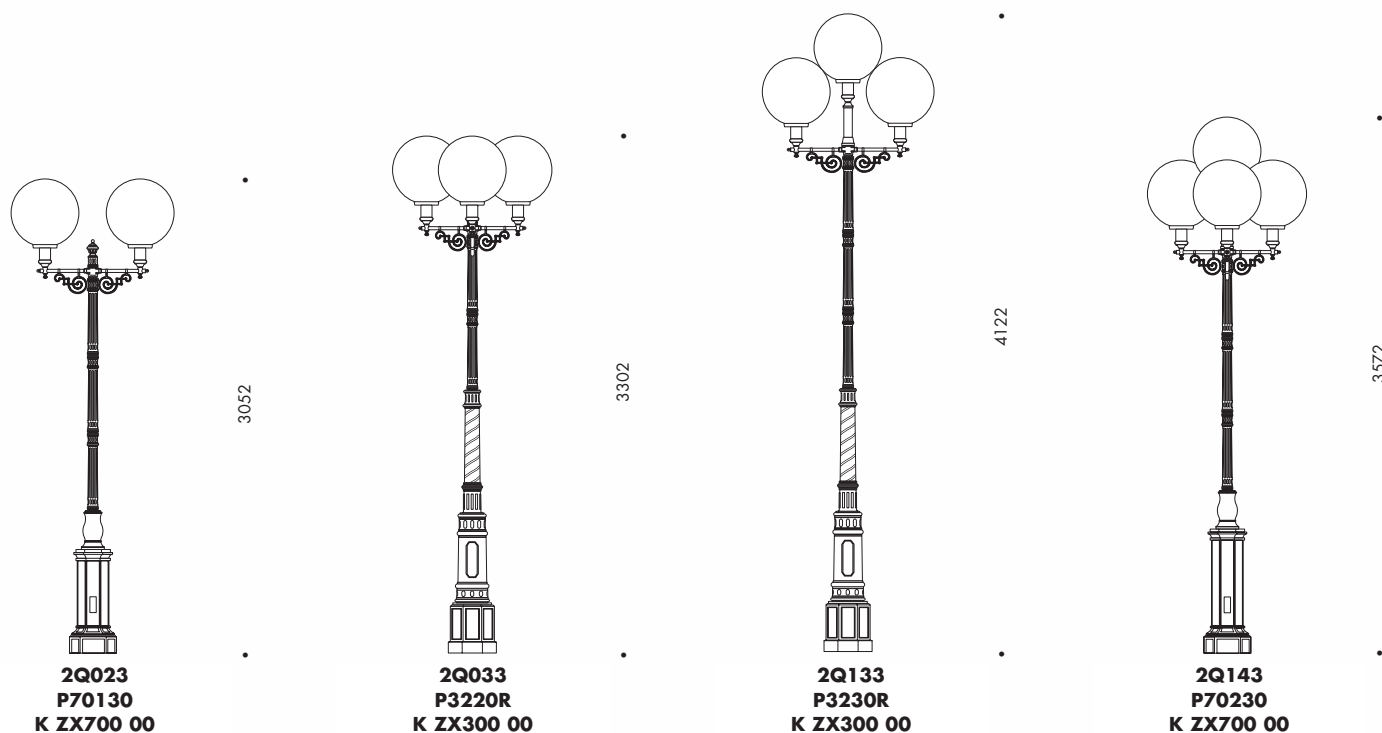



IP65  $\blacklozenge$   $\blacktriangle$   $\blacktriangle$   $\blacktriangle$   $\text{CE}$  solo gruppo ottico  
 PMMA trasparente con frangiluce o opale  
 E27 Classe I  $\oplus$   
 IAA 150W  $\leftarrow$  trasparente con frangiluce  
 FBT 27W  $\leftarrow$   
 IAA 100W  $\leftarrow$  opale

Accessori Lampade a SCARICA				
Codice	SE/ST	ME/MT	QE	
art. S	70W	70W		E27
art. X			80W	E27
art. Y			125W	E27

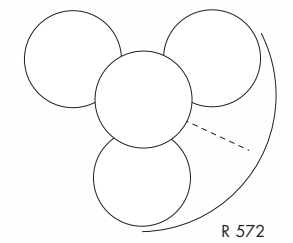
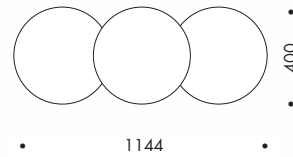
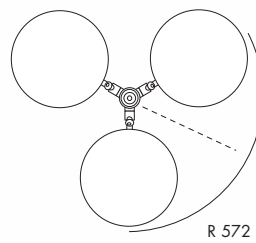
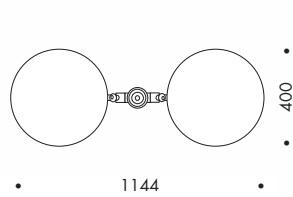
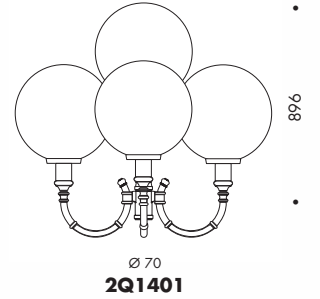
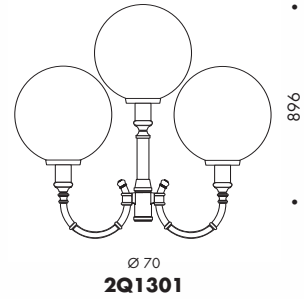
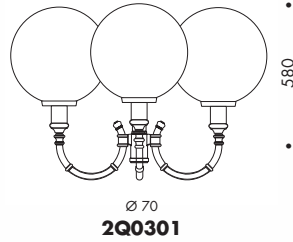
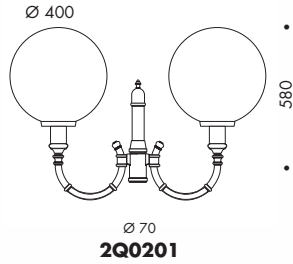

Available with clear and milky acrylic diffusers.

Nur mit klaren und opal acryl Diffusor erhältlich.

Disponible avec boules en métacrylate transparent et opal.

Disponibles con globos en metacrilato transparente y opal.

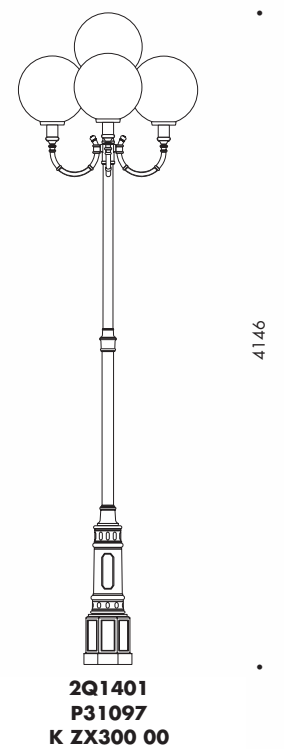
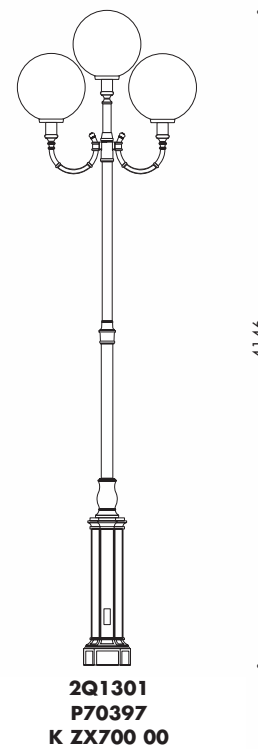
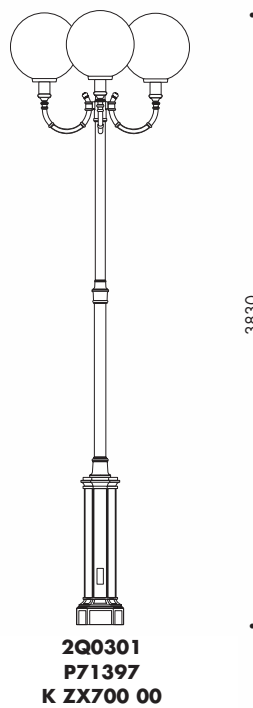
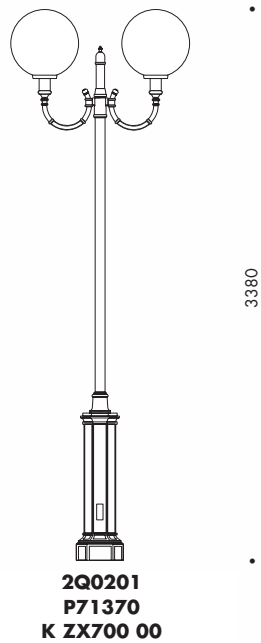





GRUPPI LANTERNE GRANDI

big lantern groups / grosse Laternen-Gruppen / ganne des grandes a plusieurs tetes / grupos de farolas grandes



IP65  $\blacklozenge$   $\blacktriangle$   $\blacktriangle$   $\blacktriangle$   $\text{CE}$  solo gruppo ottico  
 PMMA trasparente con frangiluce o opale  
 E27 Classe I  $\oplus$   
 IAA 150W  $\leftarrow$  trasparente con frangiluce  
 FBT 27W  $\leftarrow$   
 IAA 100W  $\leftarrow$  opale

Accessori Lampade a SCARICA				
Codice	SE/ST	ME/MT	QE	
art. S	70W	70W		E27
art. X			80W	E27
art. Y			125W	E27

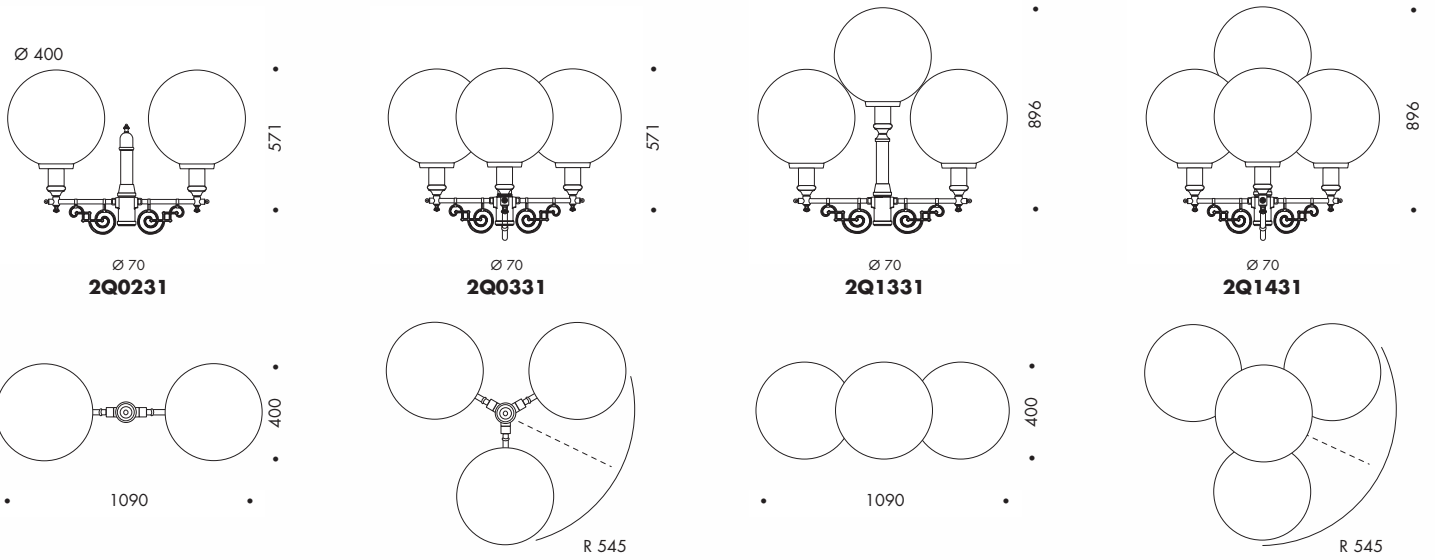

Available with clear and milky acrylic diffusers.

Nur mit klaren und opal acryl Diffusor erhältlich.

Disponibile avec boules en métacrylate transparent et opal.

Disponibles con globos en metacrilato transparente y opal.

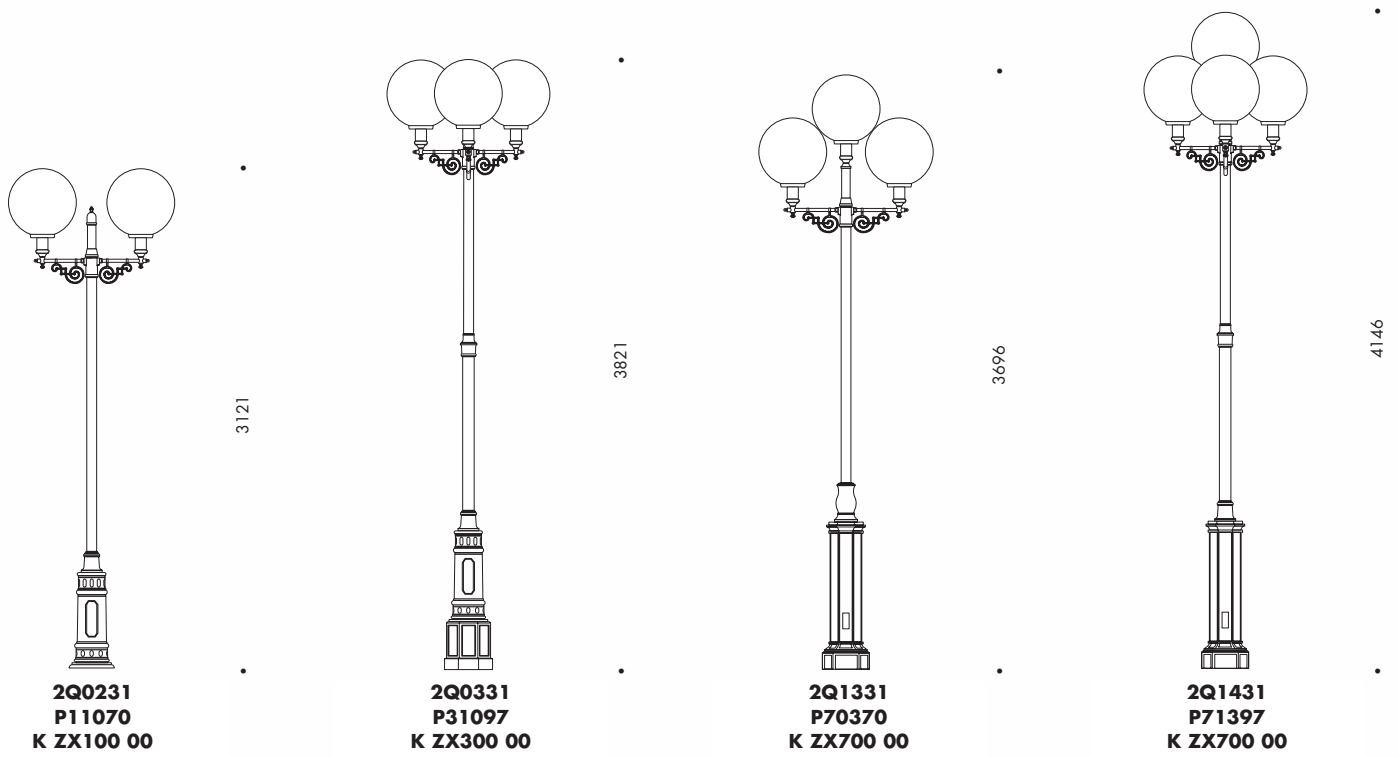





**GRUPPI LANTERNE GRANDI**

big lantern groups / grosse Laternen-Gruppen / ganne des grandes a plusieurs tetes / grupos de farolas grandes



IP65  $\blacklozenge$   $\blacktriangle$   $\blacktriangle$   $\blacktriangle$   $\text{CE}$  solo gruppo ottico  
 PMMA trasparente con frangiluce o opale  
 E27 Classe I  $\oplus$   
 IAA 150W  $\leftarrow$  trasparente con frangiluce  
 FBT 27W  $\leftarrow$   
 IAA 100W  $\leftarrow$  opale

Accessori Lampade a SCARICA				
Codice	SE/ST	ME/MT	QE	
art. S	70W	70W		E27
art. X			80W	E27
art. Y			125W	E27

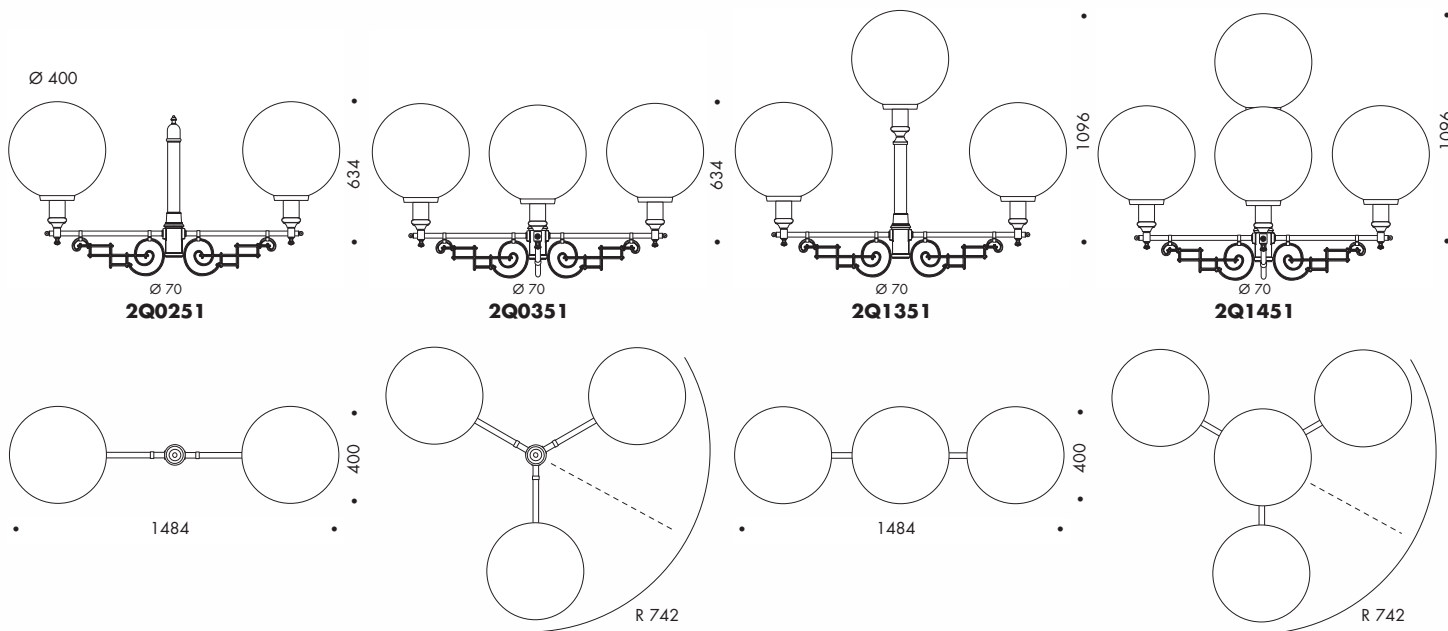

Available with clear and milky acrylic diffusers.

Nur mit klaren und opal acryl Diffusor erhältlich.

Disponibile avec boules en métacrylate transparent et opal.

Disponibles con globos en metacrilato transparente y opal.

**GRUPPI LANTERNE GRANDI**  
 big lantern groups  
 grosse Laternen-Gruppen  
 gamme des grandes a plusieurs tetes  
 grupos de farolas grandes

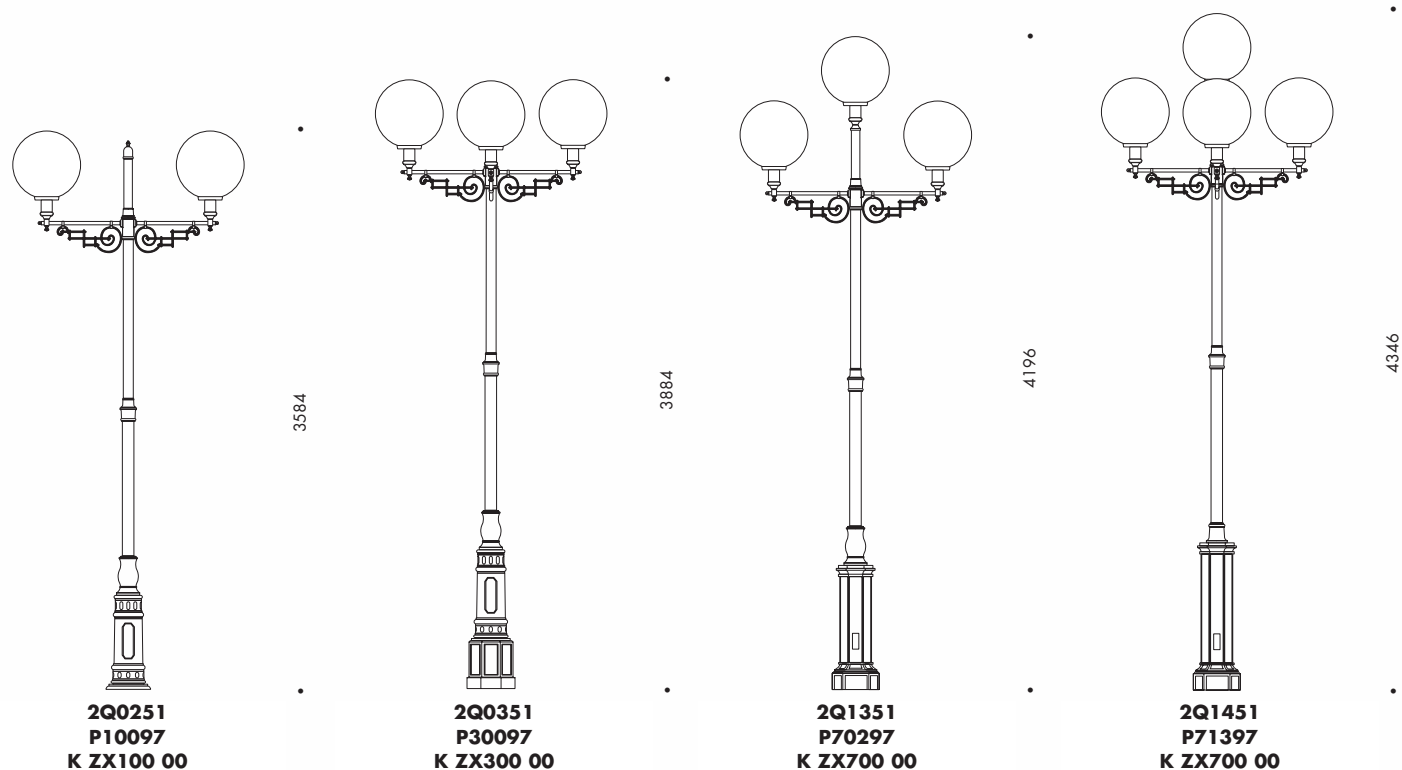





GRUPPI LANTERNE GRANDI

big lantern groups / grosse Laternen-Gruppen / ganne des grandes a plusieurs tetes / grupos de farolas grandes



IP65  $\blacklozenge$   $\blacktriangle$   $\blacktriangle$   $\blacktriangle$   $\text{CE}$  solo gruppo ottico  
 PMMA trasparente con frangiluce o opale  
 E27 Classe I  $\oplus$   
 IAA 150W  $\leftarrow$   
 FBT 27W  $\leftarrow$

Accessori Lampade a SCARICA				
Codice	SE/ST	ME/MT	QE	
art. <b>J</b>	100W			E40
art. <b>S</b>	70W	70W		E27
art. <b>T</b>		100W		E27
art. <b>Y</b>			125W	E27
art. <b>Z</b>	150W			E40

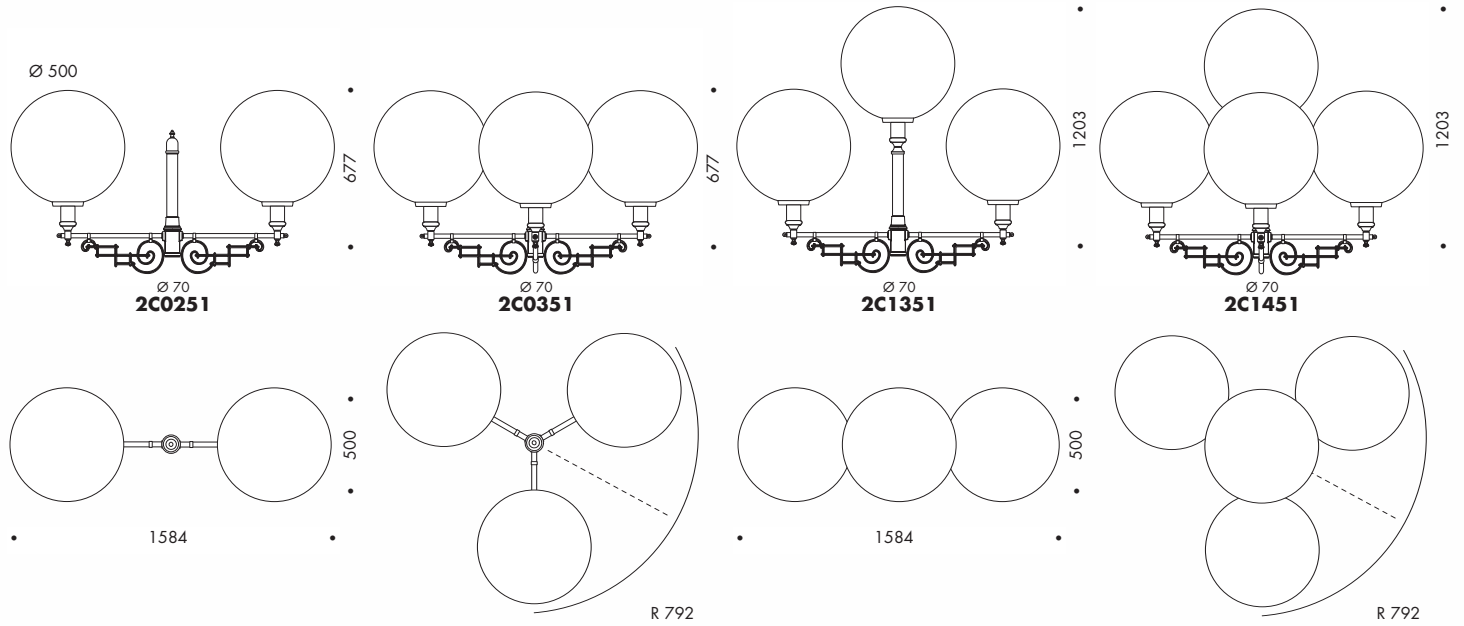

Available with clear and milky acrylic diffusers.

Nur mit klaren und opal acryl Diffusor erhältlich.

Disponible avec boules en métacrylate transparent et opal.

Disponibles con globos en metacrilato transparente y opal.

big lantern groups  
 grosse Laternen-Gruppen  
 gamme des grandes a plusieurs tetes  
 grupos de farolas grandes

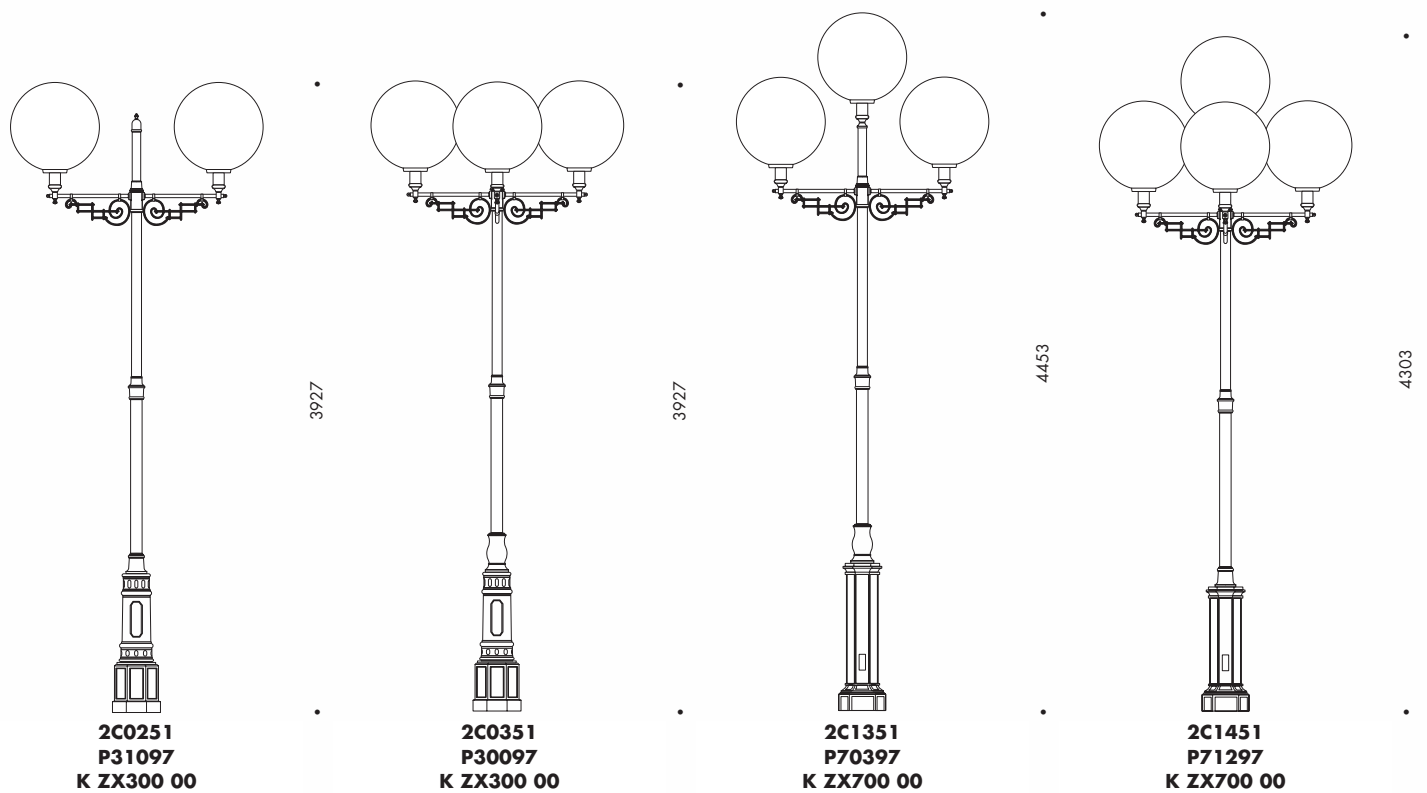

IP65 ◆ ▲ ▲ ▲ CE  
solo gruppo ottico



Cablaggio	Classe isolamento	Colore	Variante		W
S (ST-ME/MT)		L/F	ZMB	E27	70
S (ST-ME/MT)		L/F	ZMB	E27	70
J (ME-MT/ST)		L/F	ZMB	E40	100
J (ME-MT/ST)		L/F	ZMB	E40	100

Apparecchio conforme alle normative regionali in tema di lotta all'inquinamento luminoso.

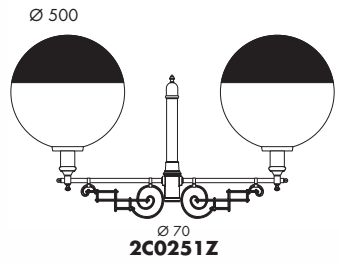

**2C0251Z**

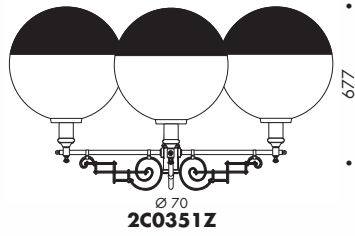

**2C0351Z**

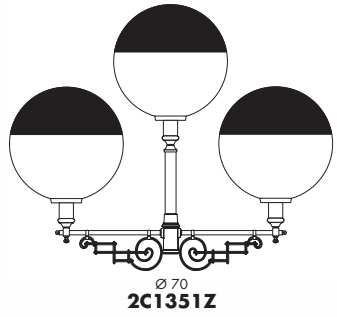

**2C1351Z**

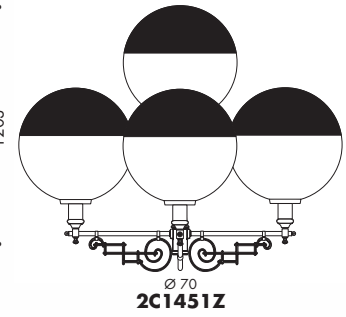

**2C1451Z**

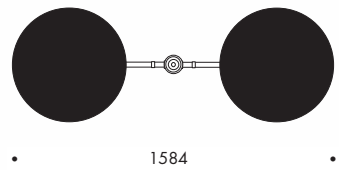

1584

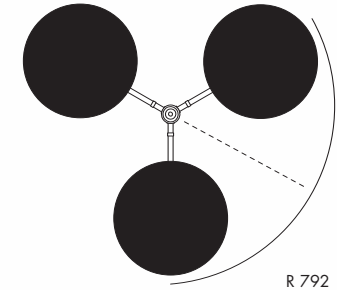

R 792

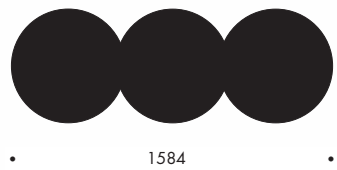

1584

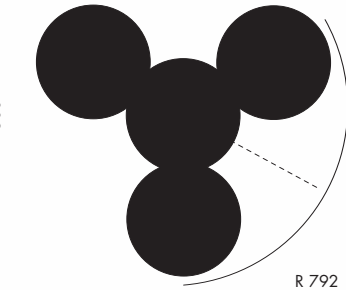

R 792

Light contamination free.

Leuchte mit Abstrahlcharakteristik gegen Lichtverschmutzung.

Appareil anti-pollution lumineuse.

Sin polucion luminosa.

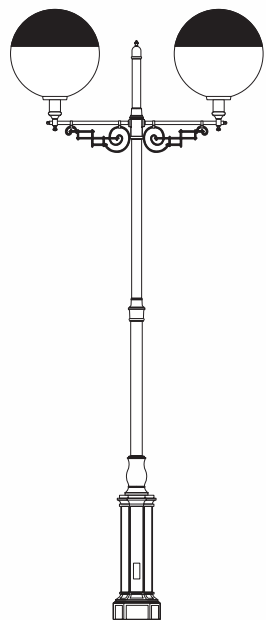

3777

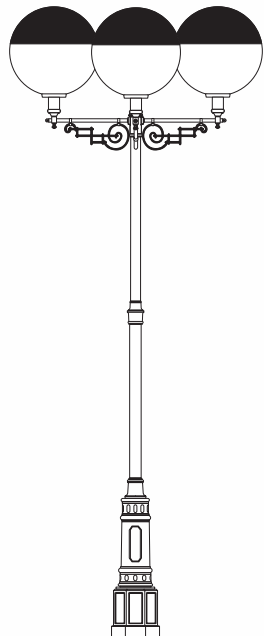

3927

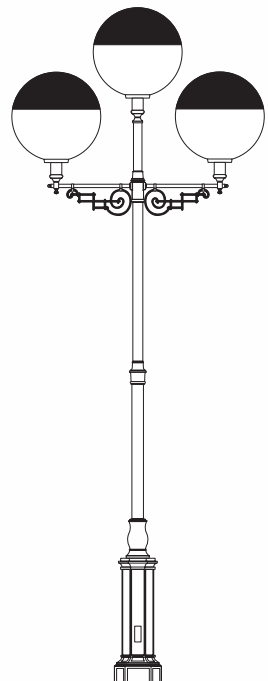

4303

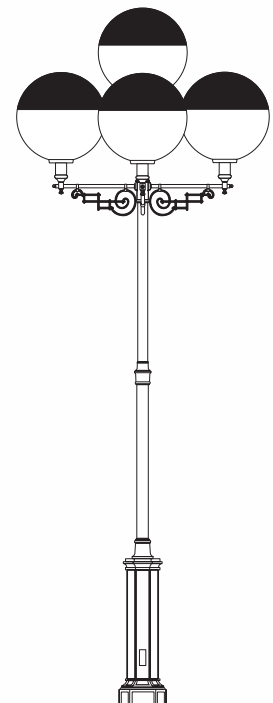

4453

**2C0251Z**  
**P70297**  
**K ZX700 00**

**2C0351Z**  
**P31097**  
**K ZX300 00**





**2C1351Z**  
**P70297**  
**K ZX700 00**

**2C1451Z**  
**P71397**  
**K ZX700 00**



IP65  CE  
solo gruppo ottico



Cablaggio	Classe isolamento	Colore	Variante		W
S (ST-ME/MT)		L / F	ZMB	E27	70
S (ST-ME/MT)		L / F	ZMB	E27	70
J (ME-MT/ST)		L / F	ZMB	E40	100
J (ME-MT/ST)		L / F	ZMB	E40	100

Esempio di codifica: 2C2P74S2 FZMB

Apparecchio conforme alle normative regionali in tema di lotta all'inquinamento luminoso.

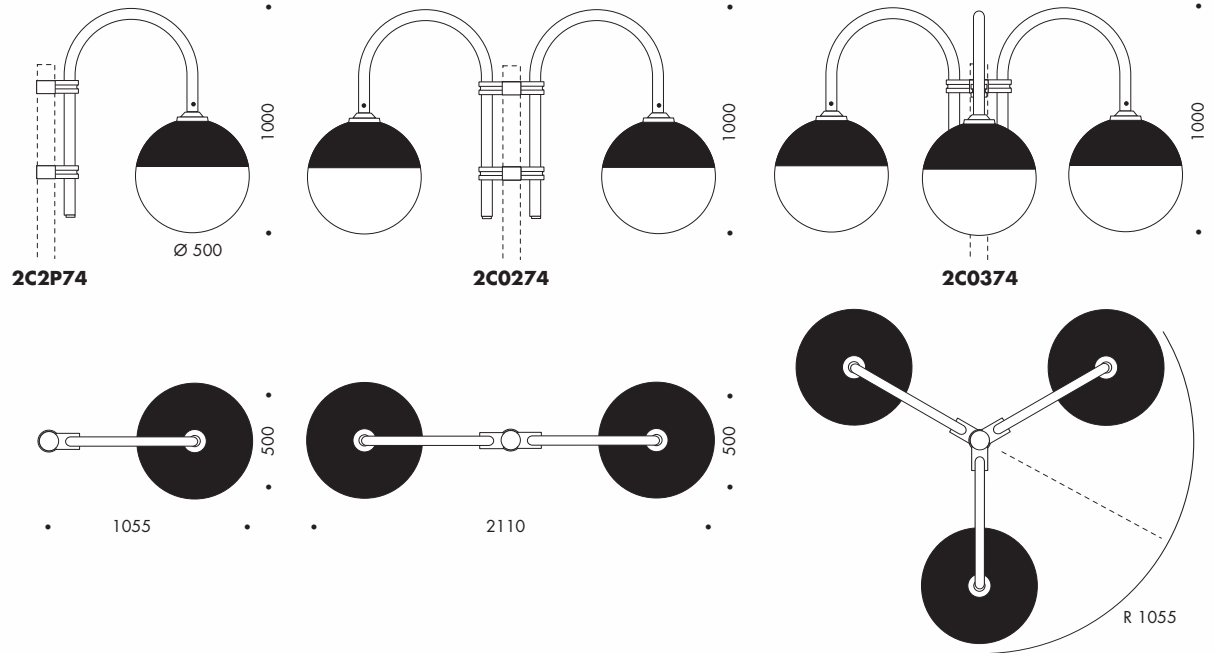

Light contamination free.

Leuchte mit Abstrahlcharakteristik gegen Lichtverschmutzung.

Appareil anti-pollution lumineuse.

Sin polucion luminosa.

big lantern groups  
grosse Laternen-Gruppen  
gamme des grandes a plusieurs tetes  
grupos de farolas grandes

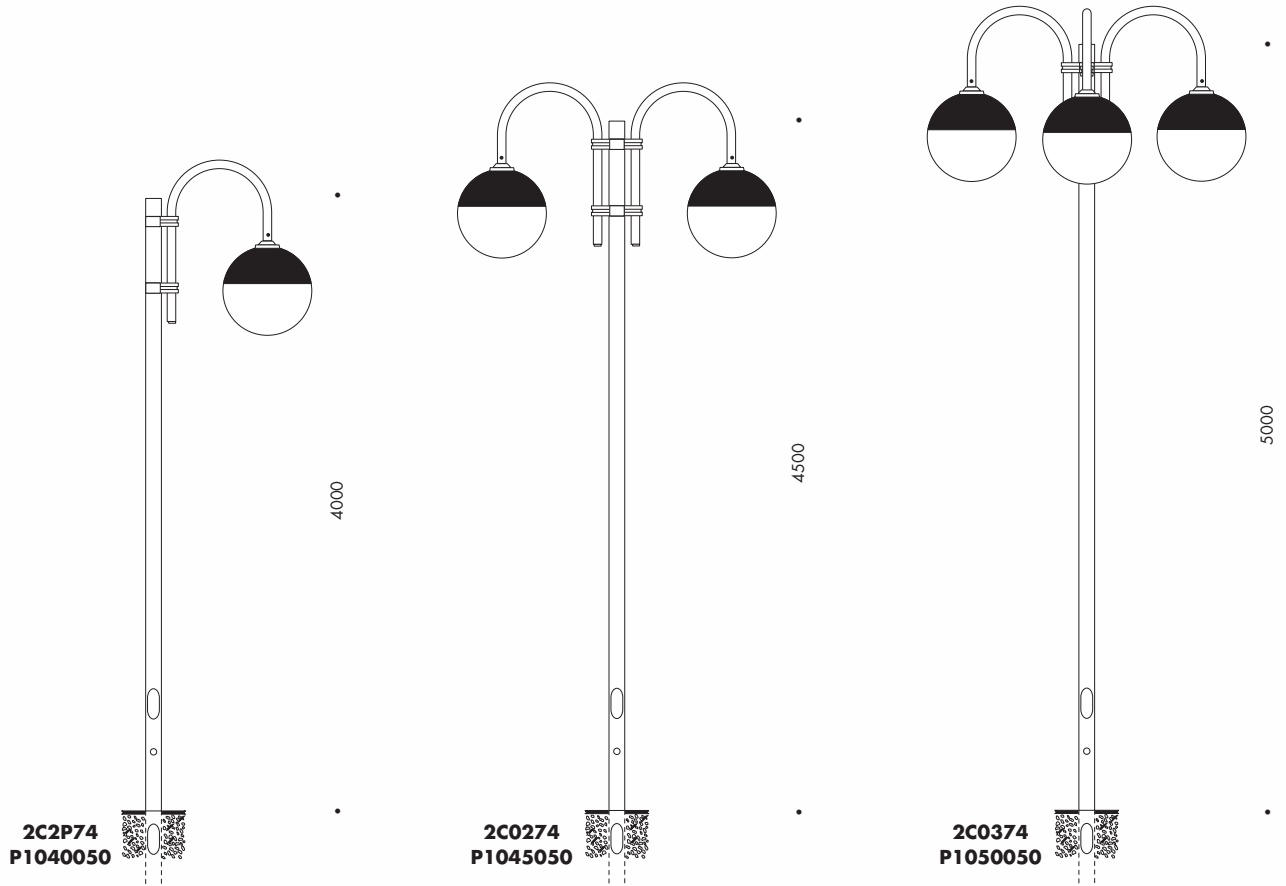





IP23    

IP43  con fondello in policarbonato trasparente

IP43  con accessorio art. R

E27 Classe I 

IAA 200W 

FBT 33W 

QB 160W 

Accessori Lampade a SCARICA					
Codice	SE	ME	MT/ST	QE	
art. S	70W	70W	70W		E27
art. T		100W			E27
art. W				50W	E27
art. X				80W	E27
art. Y	110W			125W	E27

Per una migliore comprensione delle composizioni abbiamo esemplificato usando il modello 90. E' possibile avere gli stessi gruppi ottici con i modelli 91/92/93/94/95 (mod. 91/94 anche nella versione anti-inquinamento luminoso).

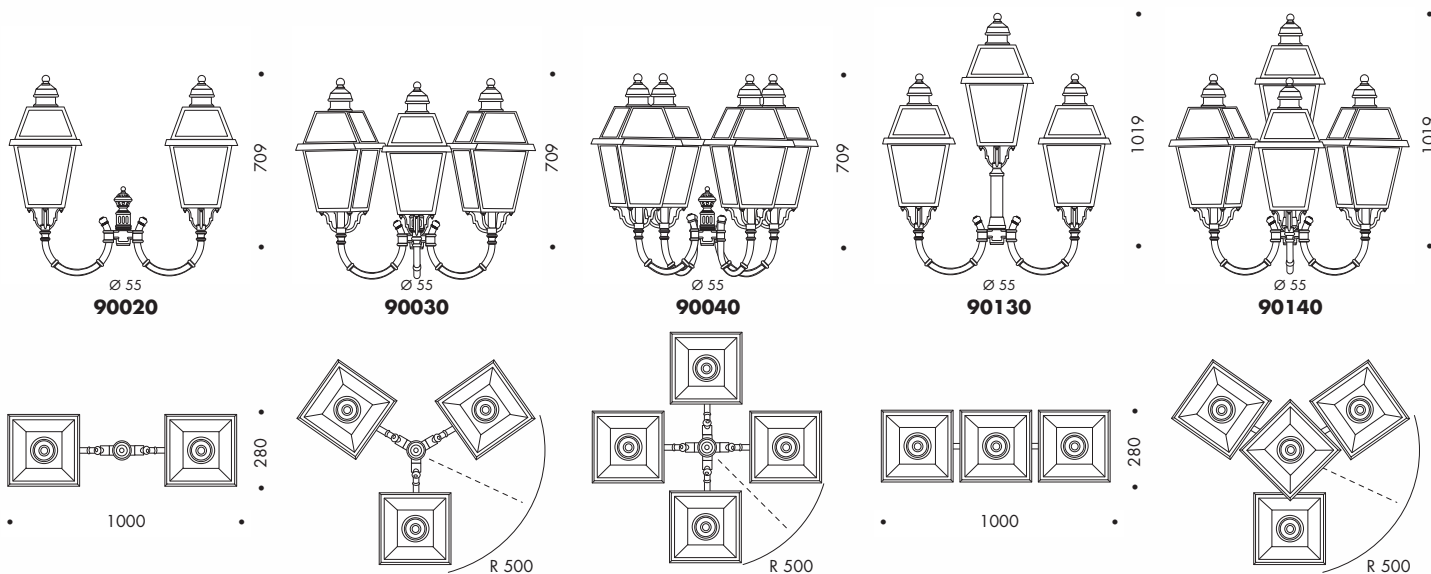

Heads are interchangeable, for a better comprehension we suggested model 90 but arrangements are available with all models 91/92/93/94/95 (mod. 91/94 light contamination free).

Im Katalog haben wir zur Vereinfachung die Modelle 90, als Beispiel, abgebildet. Es können jedoch auch die Modelle 91/92/93/94/95 (mod. 91/94 Leuchte mit Abstrahlcharakteristik gegen Lichtverschmutzung) verwendet werden.

Pour simplifier nous avons présenté le modèle 90 mais la même application peut se faire avec les modèles 91/92/93/94/95 (mod. 91/94 appareil anti-pollution lumineuse).

Para una mejor comprensión de las composiciones, hemos realizado un ejemplo con el modelo 90. Es posible tener los mismos grupos ópticos con los modelos 91/92/93/94/95 (mod. 91/94 sin polucion luminosa).

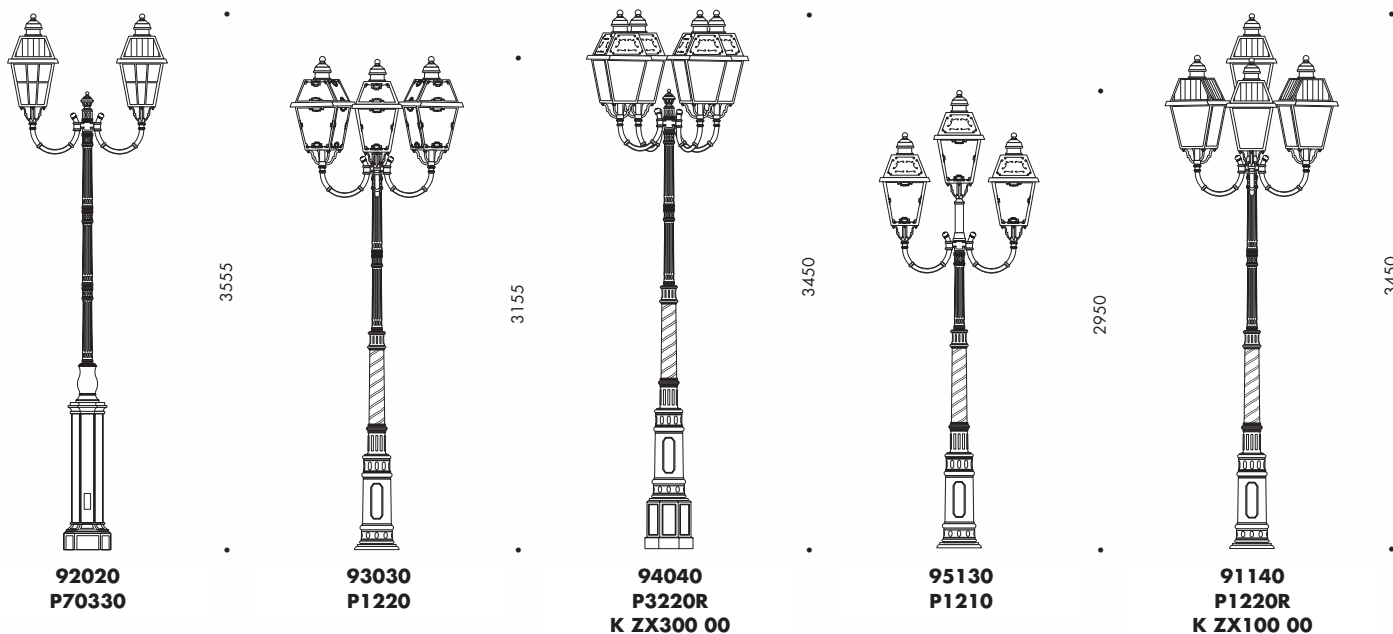





GRUPPI LANTERNE GRANDI  
big lantern groups / grosse Laternen-Gruppen / ganne des grandes a plusieurs tetes / grupos de farols grandes



IP23

IP43 con fondello in policarbonato trasparente

IP43 con accessorio art. R

E27 Classe I

IAA 200W

FBT 33W

QB 160W

Accessori Lampade a SCARICA					
Codice	SE	ME	MT/ST	QE	
art. <b>S</b>	70W	70W	70W		E27
art. <b>T</b>		100W			E27
art. <b>W</b>				50W	E27
art. <b>X</b>				80W	E27
art. <b>Y</b>	110W			125W	E27

Per una migliore comprensione delle composizioni abbiamo esemplificato usando il modello 90. E' possibile avere gli stessi gruppi ottici con i modelli 91/92/93/94/95 (mod. 91/94 anche nella versione anti-inquinamento luminoso).

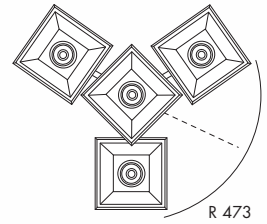
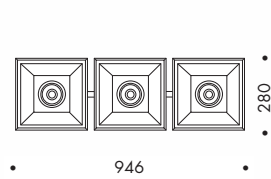
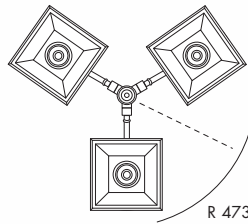
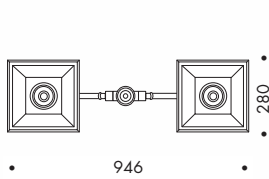
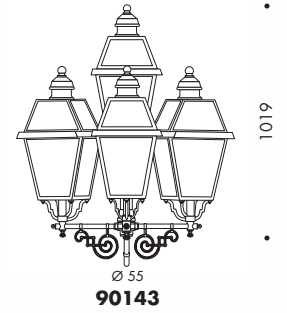
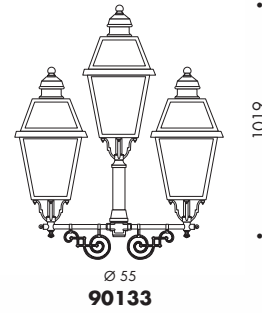
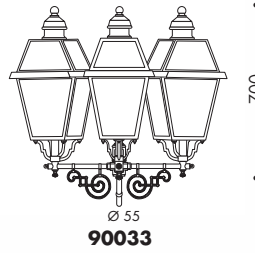
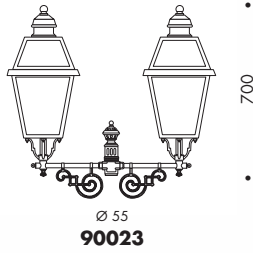

Heads are interchangeable, for a better comprehension we suggested model 90 but arrangements are available with all models 91/92/93/94/95 (mod. 91/94 light contamination free).

Im Katalog haben wir zur Vereinfachung die Modelle 90, als Beispiel, abgebildet. Es können jedoch auch die Modelle 91/92/93/94/95 (mod. 91/94 Leuchte mit Abstrahlcharakteristik gegen Lichtverschmutzung) verwendet werden.

Pour simplifier nous avons présenté le modèle 90 mais la même application peut se faire avec les modèles 91/92/93/94/95 (mod. 91/94 appareil anti-pollution lumineuse).

Para una mejor comprensión de las composiciones, hemos realizado un ejemplo con el modelo 90. Es posible tener los mismos grupos ópticos con los modelos 91/92/93/94/95 (mod. 91/94 sin polución luminosa).

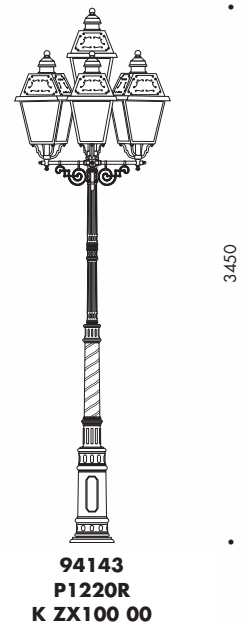
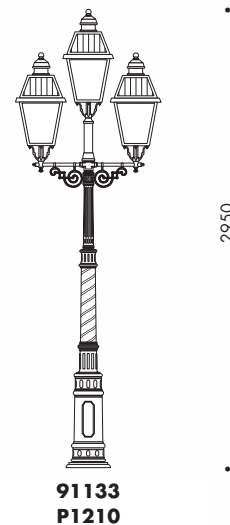
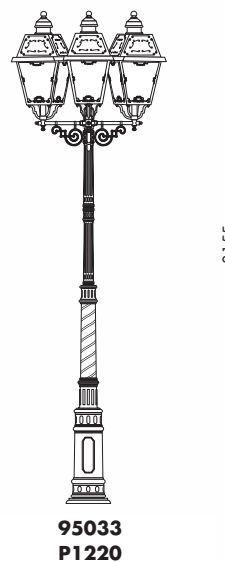
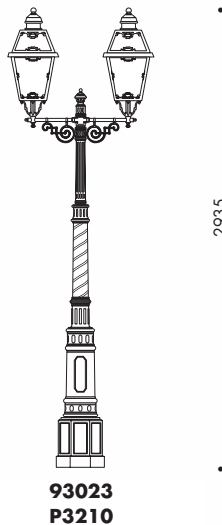

IP23    

IP43  con fondello in policarbonato trasparente

IP43  con accessorio art. R

E27 Classe I 

IAA 200W 

FBT 33W 

QB 160W 

Accessori Lampade a SCARICA					
Codice	SE	ME	MT/ST	QE	
art. S	70W	70W	70W		E27
art. T		100W			E27
art. W				50W	E27
art. X				80W	E27
art. Y	110W			125W	E27

Per una migliore comprensione delle composizioni abbiamo esemplificato usando il modello 90. E' possibile avere gli stessi gruppi ottici con i modelli 91/92/93/94/95 (mod. 91/94 anche nella versione anti-inquinamento luminoso).

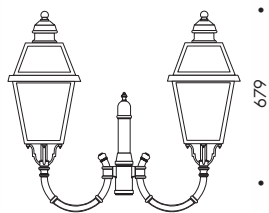

Ø 70  
**900201**

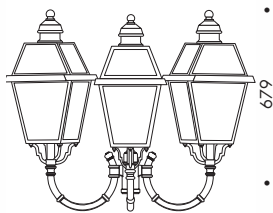

Ø 70  
**900301**

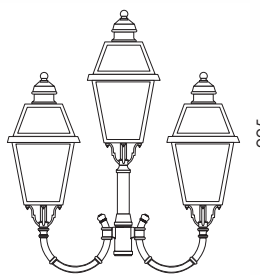

Ø 70  
**901301**

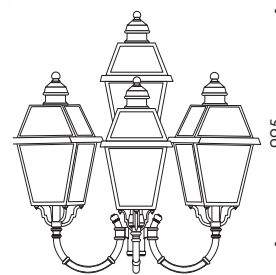

Ø 70  
**901401**

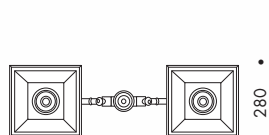

1024

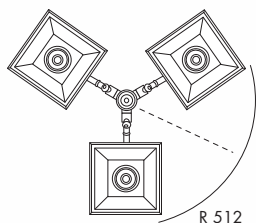

R 512

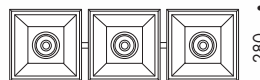

1024

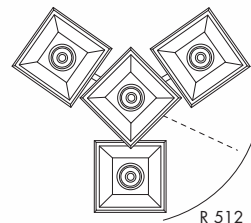

R 512

Heads are interchangeable, for a better comprehension we suggested model 90 but arrangements are available with all models 91/92/93/94/95 (mod. 91/94 light contamination free).

Im Katalog haben wir zur Vereinfachung die Modelle 90, als Beispiel, abgebildet. Es können jedoch auch die Modelle 91/92/93/94/95 (mod. 91/94 Leuchte mit Abstrahlcharakteristik gegen Lichtverschmutzung) verwendet werden.

Pour simplifier nous avons présenté le modèle 90 mais la même application peut se faire avec les modèles 91/92/93/94/95 (mod. 91/94 appareil anti-pollution lumineuse).

Para una mejor comprensión de las composiciones, hemos realizado un ejemplo con el modelo 90. Es posible tener los mismos grupos ópticos con los modelos 91/92/93/94/95 (mod. 91/94 sin polucion luminosa).

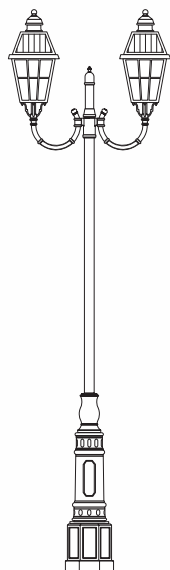

**920201**  
**P30070**

3550

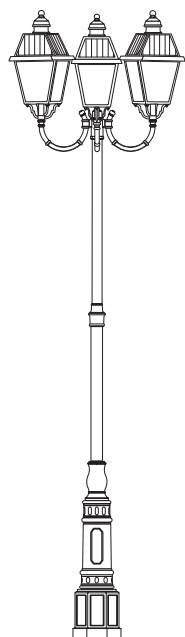

**910301**  
**P30097**  
**K ZX300 00**

3950

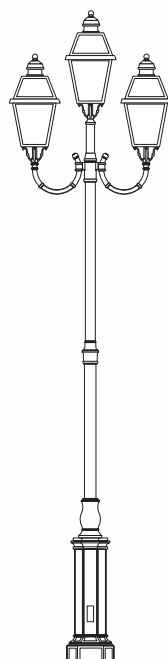

**901301**  
**P70297**  
**K ZX700 00**

4175

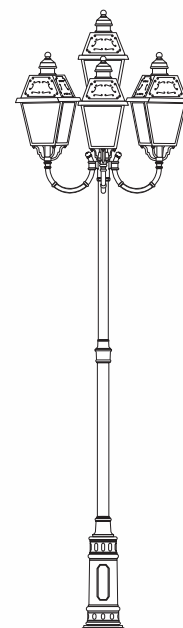

**941401**  
**P11097**  
**K ZX100 00**

4025







IP23

IP43 con fondello in policarbonato trasparente

IP43 con accessorio art. R

E27 Classe I

IAA 200W

FBT 33W

QB 160W

Accessori Lampade a SCARICA					
Codice	SE	ME	MT/ST	QE	
art. S	70W	70W	70W		E27
art. T		100W			E27
art. W				50W	E27
art. X				80W	E27
art. Y	110W			125W	E27

Per una migliore comprensione delle composizioni abbiamo esemplificato usando il modello 90. E' possibile avere gli stessi gruppi ottici con i modelli 91/92/93/94/95 (mod. 91/94 anche nella versione anti-inquinamento luminoso).

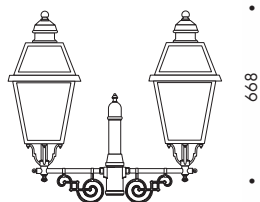

Ø 70  
**900231**

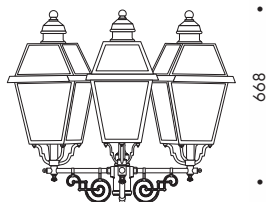

Ø 70  
**900331**

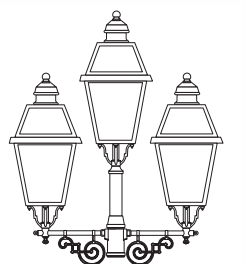

Ø 70  
**901331**

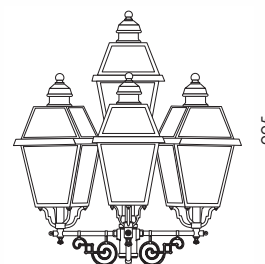

Ø 70  
**901431**

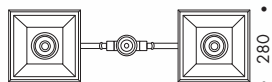

976

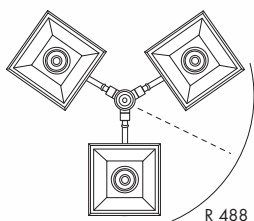

R 488

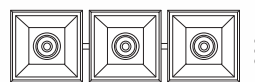

976

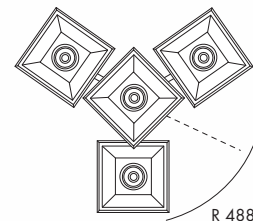

R 488

Heads are interchangeable, for a better comprehension we suggested model 90 but arrangements are available with all models 91/92/93/94/95 (mod. 91/94 light contamination free).

Im Katalog haben wir zur Vereinfachung die Modelle 90, als Beispiel, abgebildet. Es können jedoch auch die Modelle 91/92/93/94/95 (mod. 91/94 Leuchte mit Abstrahlcharakteristik gegen Lichtverschmutzung) verwendet werden.

Pour simplifier nous avons présenté le modèle 90 mais la même application peut se faire avec les modèles 91/92/93/94/95 (mod. 91/94 appareil anti-pollution lumineuse).

Para una mejor comprensión de las composiciones, hemos realizado un ejemplo con el modelo 90. Es posible tener los mismos grupos ópticos con los modelos 91/92/93/94/95 (mod. 91/94 sin polucion luminosa).

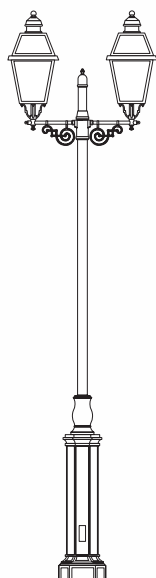

**900231**  
**P70370**

3500

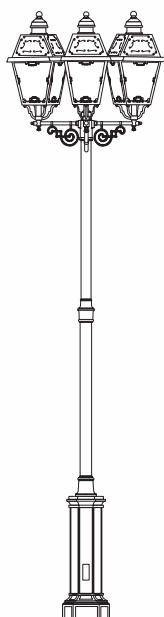

**950331**  
**P71297**  
**K ZX700 00**

3800

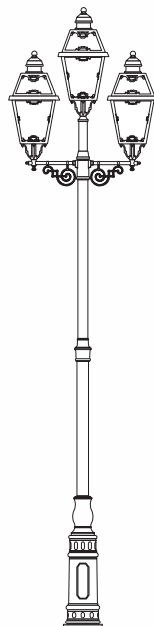

**901331**  
**P10097**  
**K ZX100 00**

4025

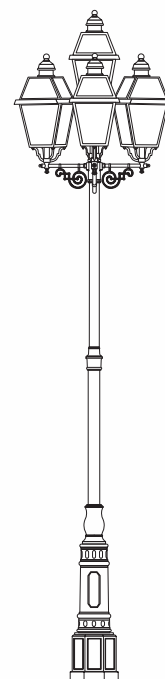

**901431**  
**P30097**  
**K ZX300 00**

4325



IP23

IP43 con fondello in policarbonato trasparente

IP43 con accessorio art. R

E27 Classe I

IAA 200W

FBT 33W

QB 160W

Accessori Lampade a SCARICA					
Codice	SE	ME	MT/ST	QE	
art. S	70W	70W	70W		E27
art. T		100W			E27
art. W				50W	E27
art. X				80W	E27
art. Y	110W			125W	E27

Per una migliore comprensione delle composizioni abbiamo esemplificato usando il modello 90. E' possibile avere gli stessi gruppi ottici con i modelli 91/92/93/94/95 (mod. 91/94 anche nella versione anti-inquinamento luminoso).

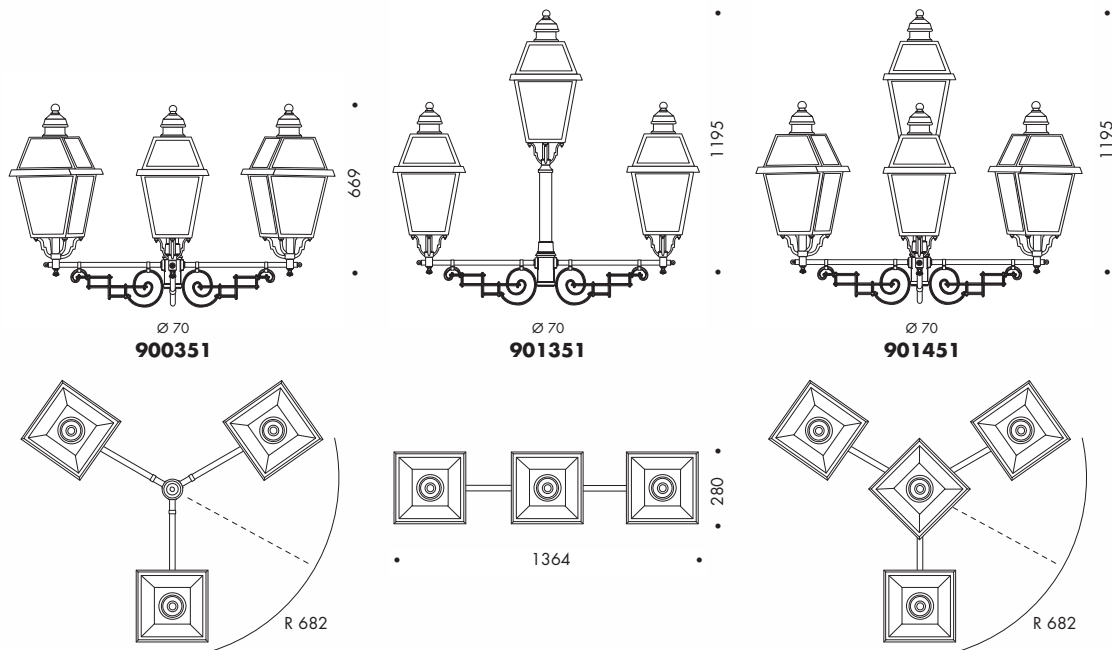

Heads are interchangeable, for a better comprehension we suggested model 90 but arrangements are available with all models 91/92/93/94/95 (mod. 91/94 light contamination free).

Im Katalog haben wir zur Vereinfachung die Modelle 90, als Beispiel, abgebildet. Es können jedoch auch die Modelle 91/92/93/94/95 (mod. 91/94 Leuchte mit Abstrahlcharakteristik gegen Lichtverschmutzung) verwendet werden.

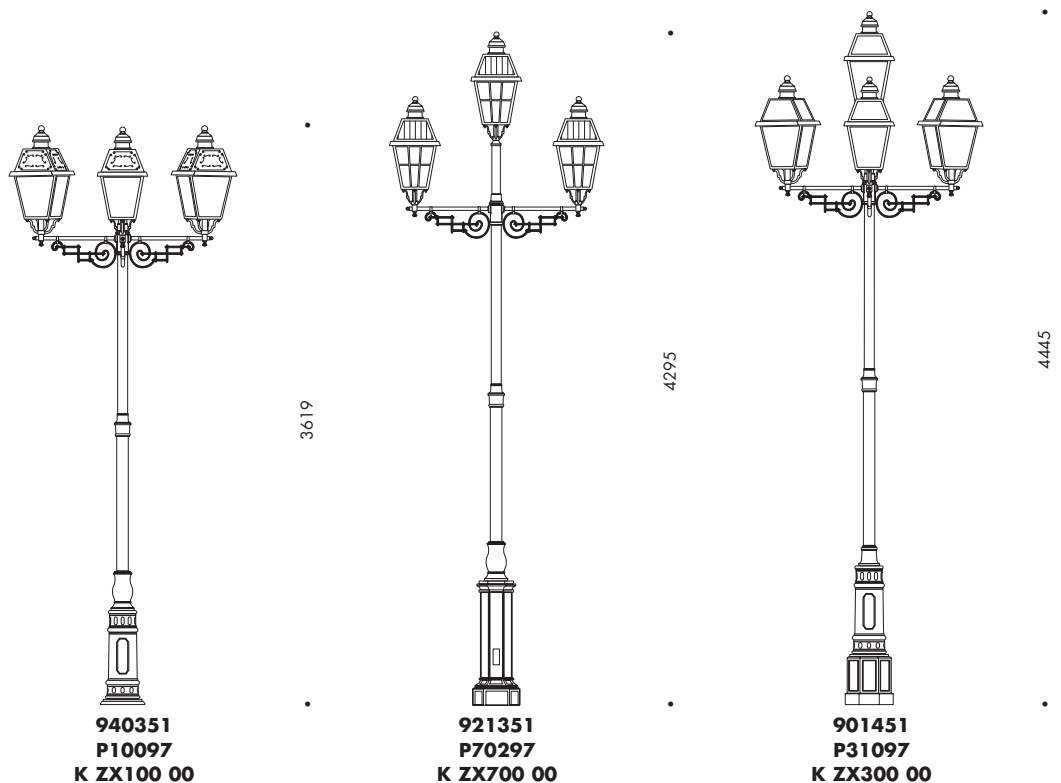

Pour simplifier nous avons présenté le modèle 90 mais la même application peut se faire avec les modèles 91/92/93/94/95 (mod. 91/94 appareil anti-pollution lumineuse).

Para una mejor comprensión de las composiciones, hemos realizado un ejemplo con el modelo 90. Es posible tener los mismos grupos ópticos con los modelos 91/92/93/94/95 (mod. 91/94 sin polución luminosa).



Apparecchio conforme alle normative regionali in tema di lotta all'inquinamento luminoso.



Codice	ST	MT	FSQ		Classe isolamento
CF			42W	Gx24q-4	
CS	70W	70W		E27	

In questa pagina mostriamo il modello 91 anti-inquinamento luminoso. E' comunque possibile avere gli stessi gruppi ottici con i modelli 90/91/92/93/94/95 (mod. 94 anche nella versione anti-inquinamento luminoso).

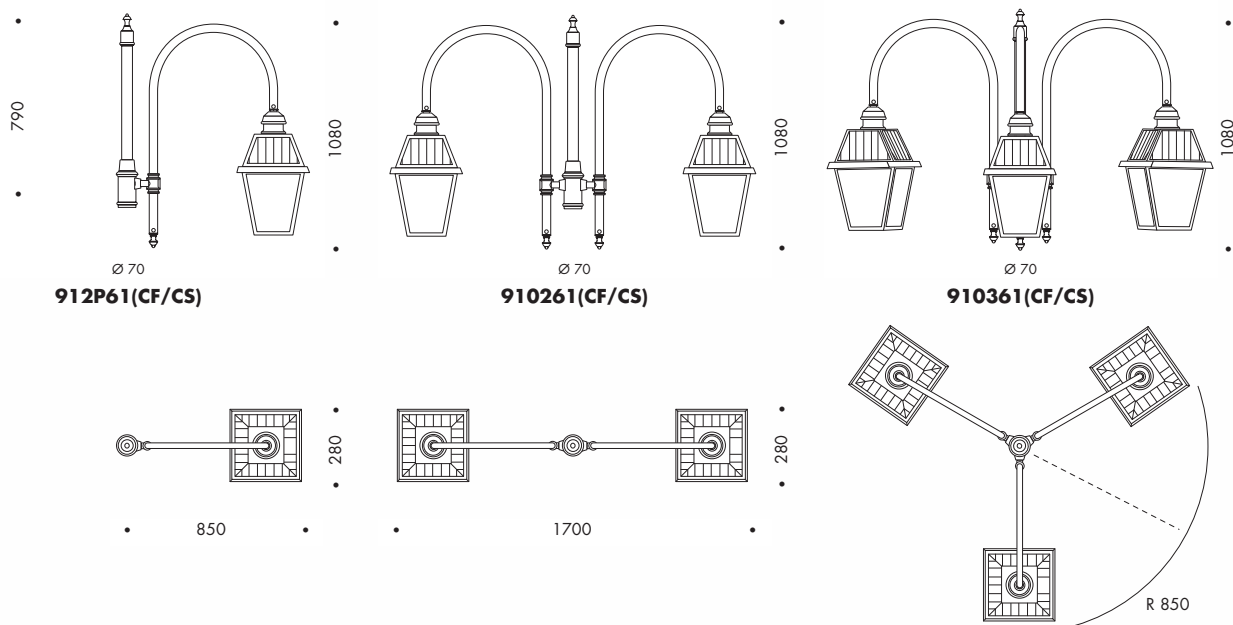

Heads are interchangeable, for a better comprehension we suggested model 91 but arrangements are available with model 94. Light contamination free.

Arrangements are available with all models 90/91/92/93/94/95.

Im Katalog haben wir zur Vereinfachung die Modelle 91, als Beispiel, abgebildet. Es koennen jedoch auch die Modelle 94 verwendet werden. Leuchte mit Abstrahlcharakteristik gegen Lichtverschmutzung.

Es koennen jedoch auch die Modelle 90/91/92/93/94/95 verwendet werden.

Pour simplifier nous avons presenté le modèle 91 mais la même application peut se faire avec le modèle 94. Appareil anti-pollution lumineuse.

La même application peut se faire avec les modèles 90/91/92/93/94/95.

Para una mejor comprensión de las composiciones, hemos realizado un ejemplo con el modelo 91. Es posible tener los mismos grupos ópticos con el modelo 94. Sin polucion luminosa.

Es posible tener los mismos grupos ópticos con los modelos 90/91/92/93/94/95.

